



# KINEX Measuring



KINEX 2020







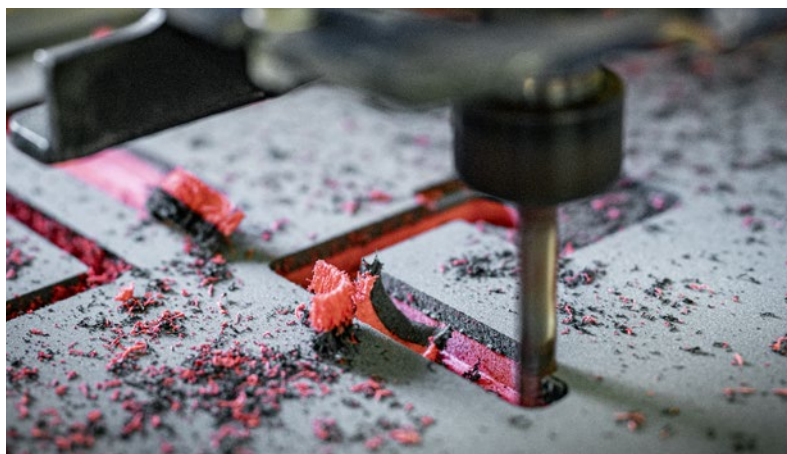
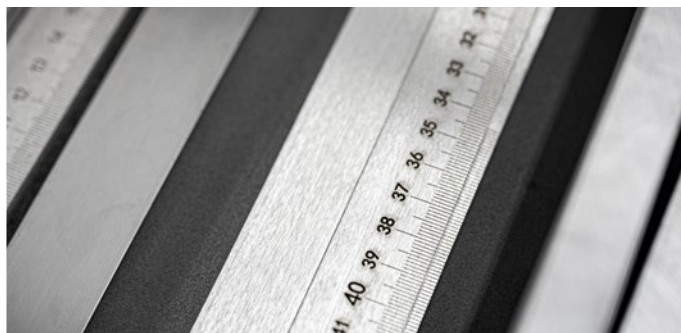













# VÝROBA MĚŘICÍCH NÁSTROJŮ MANUFACTURE OF MEASURING TOOLS PRODUKCJA PRZYRZĄDÓW POMIAROWYCH

**TRADICE OD ROKU 1893  
TRADITION SINCE 1893  
TRADYCJA OD 1893**





## Piktogramy | Pictograms | Piktogramy

 <b>IP 67</b>	Stupeň krytí Ingress Protection Marking Stopień ochrony		Rozměry šířka x výška x hloubka Dimensions Width x Height x Depth Wymiary szerokość x wysokość x głębokość
 <b>CSN</b> 25 5170	Vyrobeno dle české technické normy Manufactured according to Czech standards Wyprodukowane zgodnie z czeskimi normami technicznymi		Rozsah měření Measuring range Zakres pomiarowy
 <b>DIN</b> 863	Vyrobeno dle německé národní normy Manufactured according to German national standards Wyprodukowane zgodnie z niemieckimi normami technicznymi		Rozlišení Resolution Rozdzielczość
 <b>PN</b> 25 1125	Vyrobeno dle podnikové normy KINEX Manufactured according to company standards KINEX Wyprodukowane zgodnie ze standardami firmy KINEX		Průřez Cross-section Przekrój
 <b>INOX</b>	Vyrobeno z nerezové oceli Made of stainless steel Wyprodukowane ze stali nierdzewnej		Nestandardní přeprava Non-standard transportation Niestandardowy transport
 <b>Al</b>	Vyrobeno ze slitiny hliníku Made of aluminum alloy Wyprodukowane ze stopu aluminium		Magnetické upínání Magnetic Uchwyt magnetyczny
 <b>0</b> class	Třída přesnosti Class of accuracy Klasa dokładności		Nová řada měřidel News Nowy typ urządzeń pomiarowych
 <b>0,01</b>	Rozlišení 0,01 Resolution 0,01 Rozdzielczość 0,01		Novinka News Aktualności
 <b>0,001</b>	Rozlišení 0,001 Resolution 0,001 Rozdzielczość 0,001		Bezdrátový přenos dat - Bluetooth Wireless data transfer - Bluetooth Bezprzewodowy transfer danych - Bluetooth
 <b>2mm</b>	Rychloposuv 2mm / ot. Quick displacement 2 mm / rev Szybko odkręcana 2 mm / obr.		

e-shop: <https://shop.kinexmeasuring.com>

Aktuální katalog a ceník včetně kalibrací najdete na [www.kinexmeasuring.com](http://www.kinexmeasuring.com)

Fotografie výrobků nemusí vždy odpovídat provedení výrobku z důvodu technické obměny sortimentu.

Tiskové chyby vyhrazeny.

The current catalog and price list including calibration can be found at [www.kinexmeasuring.com](http://www.kinexmeasuring.com)

Product photos may be different from the real products due to technical upgrading of range.

Printing errors stipulated.

Aktualny katalog oraz ceny dostępne są na : [www.kinexmeasuring.com](http://www.kinexmeasuring.com)

Z powodu różnych wykonań poszczególnych narzędzi, ich wygląd nie zawsze odpowiada zdjęciom na naszych stronach i w sklepie internetowym.

Przepraszamy za błędy wynikłe w druku.

**Obsah | Contents | Zawartość**

Měřítka Rulers Przyziary	<b>2 - 5</b>	Rýsovací jehly a tužky Scribers Rysik i ołówek	<b>26</b>
Pravítka Straight edges Liniały	<b>6 - 7</b>	Vratidla Tap Wrenches Pokrętła	<b>27</b>
Příměrné desky a stoly Surface Plates, Tables Płyty traserskie i stoły	<b>8 - 9</b>	Nástavce závitníků Tap Extensions Przedłużacze do gwintowników	<b>27</b>
Rýsovací podložky V - blocks Przmy pomiarowe	<b>10</b>	Úhelníky Squares Kątowniki	<b>28 - 36</b>
Měrky Slip & Pin Gauge Sets Szczelinomierze	<b>11</b> <b>14 - 16</b>	Vodováhy Spirit Levels Poziomice	<b>37 - 40</b>
Lupy Magnifying Glasses Lupy	<b>12</b>	Posuvná měřítka Calipers Suwmiarki	<b>41 - 53</b>
Tvrdoměry Hardness Twardościomierze	<b>12</b>	Lesnické průměrky Forester Calipers Suwmiarki leśnicze	<b>53</b>
Úhloměry Protractors Kątomierze	<b>13</b>	Mikrometry Micrometers Mikrometry	<b>54 - 66</b>
Šablony Templates Szablony	<b>15</b>	Svinovací metry Measuring Tapes Miary zwijane	<b>66 - 69</b>
Stojánky Stands Podstawki	<b>17 - 18</b>	Pásma Long Tapes Miary zwijane	<b>70 - 71</b>
Úchylkoměry Indicators Czujniki	<b>19 - 21</b>	Sady Gauge Sets Zestawy	<b>72</b>
Hmatadla Internal & External Calipers Macki	<b>22</b>	Kalibry Gauges Sprawdziany	<b>73 - 77</b>
Hloubkoměry Depth Gauges Głębokościomierze	<b>23</b>	Doplňkový sortiment Additional assortment Dodatkowy asortyment	<b>78 - 80</b>
Kružidla Spring Bow Dividers Cyrkle	<b>24</b>	Lasery Lasers Lasery	<b>81 - 82</b>
Výškoměry Height Gauges Wysokościomierze	<b>25</b>	Bezdrátové měření Wireless Data Transfer Pomiar bezprzewodowy	<b>83 - 85</b>

**KINEX Measuring s.r.o.**

Podnikatelská 586  
190 11 Praha 9  
Czech Republic

tel.: +420 775 418 428  
objednavky@kinexmeasuring.com

**KINEX Measuring a.s.**

1. mája 1200  
014 01 Bytča  
Slovakia

tel.: +421 948 376 476  
odbyt@kinexmeasuring.com

**KINEX Measuring s.r.o.**

Podnikatelská 586  
190 11 Praha 9  
Czech Republic

tel.: +420 778 014 145  
export@kinexmeasuring.com

**KINEX Measuring s.r.o.**

Podnikatelská 586  
190 11 Praha 9  
Czech Republic

tel.: +48 784 764 696  
kinexpolska@kinexmeasuring.com





## Měřítka | Rulers | Przymiary

Měřítko ocelové, ploché s přesahem, popis laserem  
Steel Ruler with mm graduation, laser marking  
Przymiar kreskowy sztywny, znakowanie laserowe

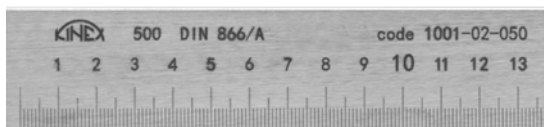

DALŠÍ ROZMĚRY NA ZAKÁZKU  
OTHER SIZES ON REQUEST  
INNE WYMIARY NA ZAMÓWIENIE

### BEZ POVRCHOVÉ ÚPRAVY | WITHOUT FINISH | NIEPOWLEKANE

CODE	L [mm]	l [mm]	s [mm]	t [mm]
1001-02-030	310	300	25	5
1001-02-050	510	500	30	6
1001-02-100	1010	1000	40	8
1001-02-150	1510	1500	40	8
1001-02-200	2010	2000	50	10
1001-02-300	3010	3000	50	10
1001-02-400	4010	4000	60	12



### NEREZOVÁ OCEL | STAINLESS STEEL | STAL NIERDZEWNA

INOX	CODE	L [mm]	l [mm]	s [mm]	t [mm]
	1001-07-030	310	300	25	5
	1001-07-050	510	500	30	6
	1001-07-100	1010	1000	40	8
	1001-07-150	1510	1500	40	8
	1001-07-200	2010	2000	50	10
	1001-07-300	3010	3000	50	10
	1001-07-400	4010	4000	60	12

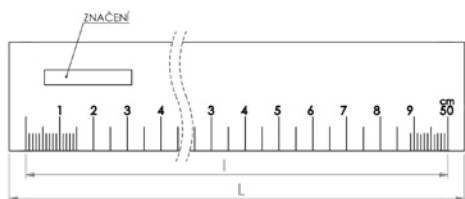

Měřítko ocelové, ploché s úkošem, popis laserem  
Stahllineal mit facette, mit mm-teilung, laserbeschriftungin  
Przymiar kreskowy sztywny ze skosem, opis laserowy

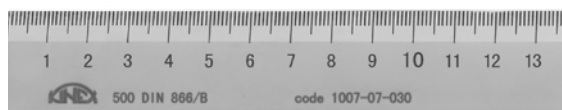

### BEZ POVRCHOVÉ ÚPRAVY | WITHOUT FINISH | NIEPOWLEKANE

CODE	L [mm]	l [mm]	s [mm]	t [mm]
1007-02-030	310	300	25	5
1007-02-050	510	500	25	5
1007-02-100	1010	1000	30	6
1007-02-150	1510	1500	30	6
1007-02-200	2010	2000	40	8
1007-02-300	3010	3000	50	8



### NEREZOVÁ OCEL | STAINLESS STEEL | STAL NIERDZEWNA

INOX	CODE	L [mm]	l [mm]	s [mm]	t [mm]
	1007-07-030	310	300	25	5
	1007-07-050	510	500	25	5
	1007-07-100	1010	1000	30	6
	1007-07-150	1510	1500	30	6
	1007-07-200	2010	2000	40	8
	1007-07-300	3010	3000	50	8

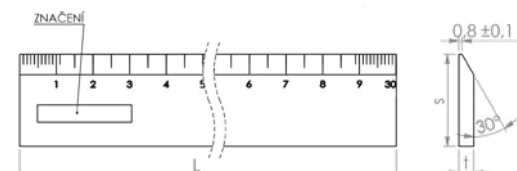

## Měřítka | Rulers | Przymiary

Měřítko ocelové ploché, začátek v nule, popis laserem  
Steel Ruler with mm graduation, laser marking  
Przymiar kreskowy sztywny, opis laserowy

**DIN**  
866/B



DALŠÍ ROZMĚRY NA ZAKÁZKU  
OTHER SIZES ON REQUEST  
INNE WYMIARY NA ZAMÓWIENIE

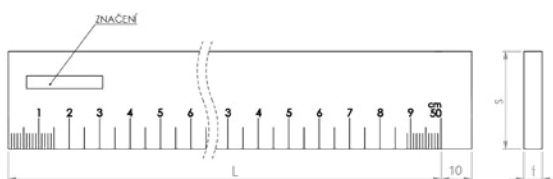

### BEZ POVRCHOVÉ ÚPRAVY | WITHOUT FINISH | NIEPOWLEKANE

CODE	L [mm]	s [mm]	t [mm]
1012-02-030	300	25	5
1012-02-050	500	25	5
1012-02-100	1000	30	6
1012-02-150	1500	30	6
1012-02-200	2000	40	8
1012-02-250	2500	40	8
1012-02-300	3000	40	8
1012-02-400	4000	50	10
1012-02-500	5000	60	12

### NEREZOVÁ OCEL | STAINLESS STEEL | STAL NIERDZEWNA

**INOX**

CODE	L [mm]	s [mm]	t [mm]
1012-07-030	300	25	5
1012-07-050	500	25	5
1012-07-100	1000	30	6
1012-07-150	1500	30	6
1012-07-200	2000	40	8

### Nemagnetické | Non-magnetic | Niemagnetyczny ULTRA-LIGHT

**AI**

CODE	L [mm]	s [mm]	t [mm]
1012-04-030	300	32	5
1012-04-050	500	32	5
1012-04-100	1000	32	5

Měřítko ocelové ploché, začátek v nule, stupnice INCH, popis laserem  
Steel Ruler with INCH graduation, laser marking  
Przymiar kreskowy sztywny, skala INCH, opis laserowy

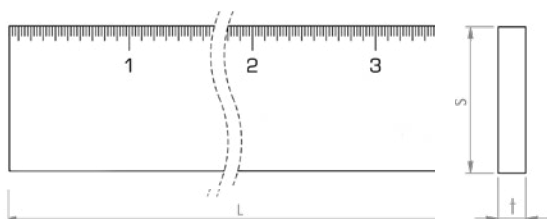

### NEREZOVÁ OCEL | STAINLESS STEEL | STAL NIERDZEWNA

**INOX**

CODE	L	s [mm]	t [mm]
1012-07-024	24"	25	5
1012-07-040	40"	32	6

Měřítko s vertikální stupnicí, popis laserem  
Steel Ruler with vertical mm scale, laser marking  
Przymiar kreskowy sztywny z pionową skalą, opis laserowy

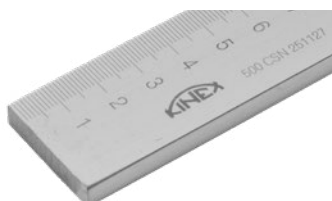

### NEREZOVÁ OCEL | STAINLESS STEEL | STAL NIERDZEWNA

**INOX**

CODE	L [mm]	s [mm]	t [mm]
1027-07-050	500	25	5
1027-07-100	1000	32	6



## Měřítka | Rulers | Przymiary

Měřítko ocelové tenké BLACK COAT, laser: popis (vhodné pro kalibraci)  
 Steel Thin Ruler BLACK COAT, laser marking (suitable for calibration)  
 Przymiar kreskowy półsztywny BLACK COAT, opis laser: (nadaje się do kalibracji)

1

EC-DIN  
2004/22

I  
class

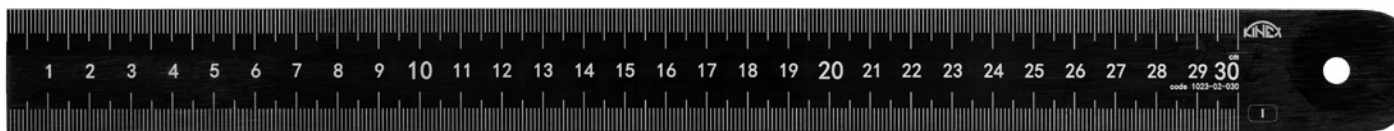

CODE	L [mm]	s [mm]	t [mm]
1023-02-030	300	30	1
1023-02-050	500	30	1
1023-02-100	1000	30	1

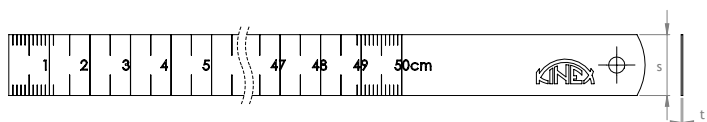

Měřítko ocelové tenké, laserový popis (vhodné pro kalibraci)  
 Steel Thin Ruler, laser marking (suitable for calibration)  
 Przymiar kreskowy półsztywny, opis laserowy (nadaje się do kalibracji)

1

EC-DIN  
2004/22

I  
class



CODE	L [mm]	s [mm]	t [mm]
1023-05-030	300	30	1
1023-05-050	500	30	1
1023-05-100	1000	30	1
1023-05-150	1500	30	1
1023-05-200	2000	30	1

Měřítko ocelové tenké, laserový popis (vhodné pro kalibraci)  
 Steel Thin Ruler, laser marking (suitable for calibration)  
 Przymiar kreskowy półsztywny, opis laserowy (nadaje się do kalibracji)

0,5

EC-DIN  
2004/22

I  
class

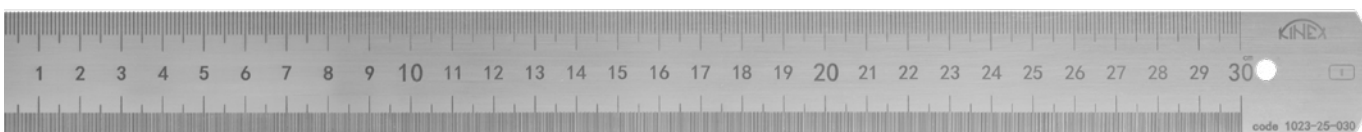

CODE	L [mm]	s [mm]	t [mm]
1023-25-030	300	30	1
1023-25-050	500	30	1
1023-25-100	1000	30	1

## Měřítka | Rulers | Przymiary

Měřítka ocelové tenké - barevné značení, převodní tabulka, laserový popis  
Steel Thin Ruler - color marking, conversion table, laser marking  
Przymiar kreskowy pólstywny, tabela przeliczeniowa, opis laserowy

Měřítka ocelové tenké, laserový popis  
Steel Thin Ruler, laser marking  
Przymiar kreskowy elastyczny, opis laserowy

1

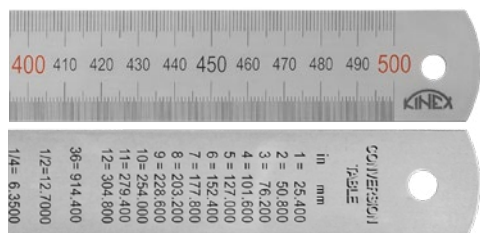

0,5



CODE	L [mm]	s [mm]	t [mm]
1022-02-030	300	25	1
1022-02-050	500	30	1
1022-02-100	1000	30	1

CODE	L [mm]	s [mm]	t [mm]
1022-0	150	13	0,5
1022-1	200	13	0,5
1022	300	25	1,0
1023	500	30	1,0
1024	1000	38	2,0
1025	1500	38	2,0
1026	2000	40	2,0

Měřítka ocelové ohebné BLACK COAT, laser. popis  
Steel Thin Ruler KINEX BLACK COAT, laser marking  
Przymiar kreskowy pólstywny BLACK COAT, opis laser.

1

INOX

I  
class



CODE	L [mm]	s [mm]	t [mm]
1017-02-015	150	13	0,5
1017-02-030	300	13	0,5
1017-02-050	500	15	0,5
1017-02-100	1000	20	0,5
1017-02-150	1500	20	0,5
1017-02-200	2000	20	0,5



CODE	L [mm]	s [mm]	t [mm]
1017-05-015	150	13	0,5
1017-05-030	300	13	0,5
1017-05-050	500	15	0,5
1017-05-100	1000	20	0,5

Měřítka ocelové ohebné, laserový popis  
Flexible Steel Ruler, laser marking (suitable for calibration)  
Przymiar kreskowy pólstywny, opis laserowy

1

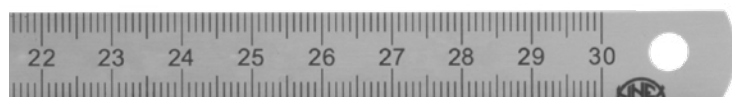

CODE	L [mm]	s [mm]	t [mm]
1017	300	13	0,5
1018	500	15	0,5
1019	1000	20	0,5
1020	1500	20	1,2
1021	2000	20	1,2





## Pravítka | Straight Edges | Liniály

Pravítko kontrolní (k měření rovinnosti), popis laserem  
Precision Straight Edge (for measuring flatness), laser marking  
Liniál kontrolny do pomiaru płaskości, opis laserowy

**DIN**  
874



### BEZ POVRCHOVÉ ÚPRAVY | WITHOUT FINISH | NIEPOWLEKANE

**0**  
class

CODE	L [mm]	s [mm]	t [mm]
1039-02-050	500	50	10
1039-02-075	750	50	10
1039-02-100	1000	60	12
1039-02-150	1500	70	15
1039-02-200	2000	80	15
1039-02-250	2500	100	16
1039-02-300	3000	120	20
1039-02-400	4000	140	20

**I**  
class

CODE	L [mm]	s [mm]	t [mm]
1039-12-050	500	40	8
1039-12-075	750	50	10
1039-12-100	1000	50	10
1039-12-150	1500	60	12
1039-12-200	2000	70	15
1039-12-250	2500	80	15
1039-12-300	3000	100	16
1039-12-400	4000	120	20

**II**  
class

CODE	L [mm]	s [mm]	t [mm]
1039-22-050	500	30	6
1039-22-075	750	40	8
1039-22-100	1000	40	8
1039-22-150	1500	50	10
1039-22-200	2000	60	12
1039-22-250	2500	70	15
1039-22-300	3000	80	15
1039-22-400	4000	100	16
1039-22-500	5000	120	20

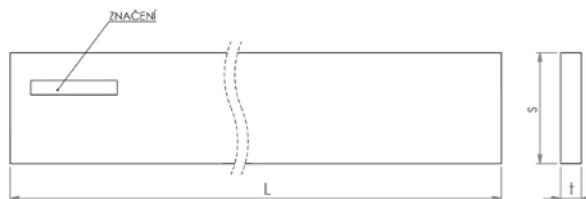

DALŠÍ ROZMĚRY NA ZAKÁZKU  
OTHER SIZES ON REQUEST  
INNE WYMIARY NA ZAMÓWIENIE

Pravítko kontrolní (k měření rovinnosti), popis laserem  
Precision Straight Edge (for measuring flatness), laser marking  
Liniál kontrolny do pomiaru płaskości, opis laserowy

**DIN**  
874



### NEREZ OCEĽ | NEREZ OCEĽ | STAL NIERDZEWNA

**I**  
class

CODE	L [mm]	s [mm]	t [mm]
1039-17-050	500	40	8
1039-17-075	750	50	10
1039-17-100	1000	50	10
INOX 1039-17-150	1500	60	12
1039-17-200	2000	60	12
1039-17-250	2500	80	15
1039-17-300	3000	100	16
1039-17-400	4000	120	18

**I**  
class

### ALUMINIUM

**AI**

CODE	L [mm]	s [mm]	t [mm]
1039-14-050	500	60	12
1039-14-100	1000	60	12
1039-14-150	1500	100	16
1039-14-200	2000	100	16

DALŠÍ TŘÍDY PŘESNOSTI NA ZAKÁZKU  
OTHER ACCURACY CLASSES ON REQUEST  
INNE KLASY DOKŁADNOŚCI NA ZAMÓWIENIE

## Pravítka | Straight Edges | Liniały

Pravítko kontrolní odlehčené (k měření rovinnosti)  
Precision Straight Edge (for measuring flatness)  
Lekki liniał do kontroli płaskości

**II**  
class



CODE	↔
1038-02-050	50x50x500 mm
1038-02-100	50x50x1000 mm
1038-02-150	50x50x1500 mm

DALŠÍ ROZMĚRY NA ZAKÁZKU | OTHER SIZES ON REQUEST | INNE WYMIARY NA ZAMÓWIENIE

Pravítko mostové kontrolní - litinové  
Bridge Type Straight Edge  
Liniał powierzchniowy żebrowany - żeliwo

**DIN**  
876



CODE	↔
<b>I</b> class 1033-12-050	500x40 mm
1033-12-075	750x45 mm
CODE	↔
<b>II</b> class 1033-22-100	1000x50 mm
1033-22-150	1500x60 mm
1033-22-200	2000x70 mm

Pravítko nožové kalené  
Knife Edge Straight Edge  
Liniał krawędziowy hartowany

**DIN** 874-2 **00** class

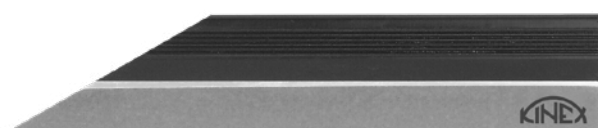

**00**  
class

**NEW**  
LINE

CODE	↔
1061-05-075	75x25x5 mm
1061-05-100	100x25x5 mm
1061-05-125	125x25x5 mm
1061-05-150	150x25x5 mm
1061-05-200	200x29x7 mm
1061-05-300	300x29x7 mm
1061-05-400	400x33x10 mm
1061-05-500	500x33x10 mm

**00**  
class

NEREZOVÁ OCEL | STAINLESS STEEL | STAL NIERDZEWNA

CODE	↔
1061-07-075	75x25x5 mm
1061-07-100	100x25x5 mm
1061-07-125	125x25x5 mm
1061-07-150	150x25x5 mm
1061-07-200	200x29x7 mm
1061-07-300	300x29x7 mm
1061-07-400	400x33x10 mm
1061-07-500	500x33x10 mm
1061-07-600	600x45x10 mm
1061-07-750	750x60x12 mm
1061-07-1000	1000x60x12 mm

- » kalené na 55HRC a broušené
- » funkční plochy lapovány
- » ochranná izolace proti přechodu tepla

- » 55HRC hardened and grinded
- » functional surfaces lapped
- » thermal insulation

- » 55HRC hartowane i szlifowane
- » funkcjonalne powierzchnie docierane
- » izolacja termiczna



## Příměrné desky a stoly | Surface Plates, Tables | Płyty traserskie i stoly

Příměrná deska granitová, jemně lapovaná diamantem  
Granite Surface Plate, gently lapped with diamond  
Płyty pomiarowe granitowe

**DIN**  
876/0



DALŠÍ ROZMĚRY NA ZAKÁZKU  
OTHER SIZES ON REQUEST  
INNE WYMIARY NA ZAMÓWIENIE

CODE	↔
1041-02-030	300x300x70 mm
1041-02-040	400x400x100 mm
1041-02-063	630x400x100 mm
1041-02-100	1000x630x150 mm
1041-02-120	1200x800x150 mm
1041-02-160	1600x1000x200 mm
1041-02-210	2000x1000x250 mm
1041-02-216	2000x1600x300 mm

Příměrná deska litinová  
Cast Iron Surface Plate  
Płyty traserskie żeliwne

**DIN**  
876/1



Pro dosažení uvedené přesnosti je třeba ustavit desku na stole KINEX.

To achieve its accuracy it is necessary to set the plate on the KINEX table.

Aby osiągnąć podaną dokładność konieczne jest ustawienie płyty na stole KINEX.

DALŠÍ ROZMĚRY NA ZAKÁZKU  
OTHER SIZES ON REQUEST  
INNE WYMIARY NA ZAMÓWIENIE

CODE	↔
1042-02-030	300x300x65mm
1042-02-040	400x400x65mm
1042-02-060	600x450x75mm
1042-02-080	800x600x85mm
1042-02-100	1000x800x105mm
1042-02-120	1200x800x160mm

Stůl pod granitovou desku PROFI - svařované z jeklu, lakované  
Table for Granite Surface Plate - welded hollow, lacquered  
Stoly PROFI do płyt granitowych, spawane, malowane

Podstavec litinové desky PROFI - svařované z jeklu, lakované  
Table for Cast Iron Surface Plate - welded hollow, varnished  
Stoly PROFI do płyt żeliwnych, spawane, malowane



CODE	↔	pro   pre   dla
1041-12-040	224x224x700 mm	1041-02-040
1041-12-063	355x224x700 mm	1041-02-063
1041-12-100	560x355x700 mm	1041-02-100
1041-12-120	675x450x700 mm	1041-02-120
1041-12-160	900x560x700 mm	1041-02-160

CODE	↔	pro   pre   dla
1042-12-030	300x300x600 mm	1042-02-030
1042-12-040	400x400x600 mm	1042-02-040
1042-12-060	600x450x600 mm	1042-02-060
1042-12-080	800x600x600 mm	1042-02-080
1042-12-100	1000x800x600 mm	1042-02-100

## Příměrné desky a stoly | Surface Plates, Tables | Płyty traserskie i stoly

Granitový kontrolní úhelník 90°  
Precision Granite Square 90°  
Kątownik kontrolny granitowy 90°



GRANITOVÉ KOSTKY A ÚHELNÍKY  
BROUSÍME A DODÁVÁME NA ZAKÁZKU

GRANITE CUBES AND SQUARES  
GRIND AND DELIVER TO ORDER

GRANITOWE KOSTKI, TRÓJKĄTY  
I KWADRATY SZLIFUJEMY I  
DOSTARCZAMY W RÓŻNYCH  
ROZMIARACH  
NA ŻYCZENIE KLIENTA

00  
class

CODE	
1041-80	100x63x16 mm
1041-82	160x100x20 mm
1041-84	250x160x25 mm
1041-86	400x250x40 mm
1041-88	630x400x80 mm
1041-90	1000x630x80 mm

Na vyžádání nabízíme i verzi s garantovanou přesností všech měrných ploch od 0,2 μm.

Upon request, we also offer a version with a guaranteed accuracy of all measurement areas from 0,2 μm.

Na życzenie oferujemy również wersję z gwarantowaną dokładnością wszystkich powierzchni pomiarowych od 0,2 μm.



## Rýsovací podložky | V - blocks | Pryzmy pomiarowe

Rýsovací podložky se zářezy - dodáváno v páru, kaleno na 60 HRC

V - BLOCKS (Pair), hardened to 60 HRC

Pryzmy pomiarowe z wycięciami - dostarczamy w parach, hartowane do 60 HRC



### S JEDNÍM ZÁŘEZEM | 1 SLOT | Z JEDNYM WYCIĘCIEM

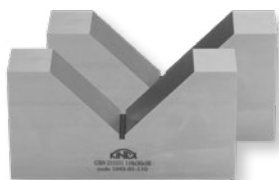

CODE	L	S	V	Z	$\alpha$
1043-01-110	110	30	58	70	90°
1043-01-140	140	40	80	90	90°
1043-01-200	200	55	120	130	90°

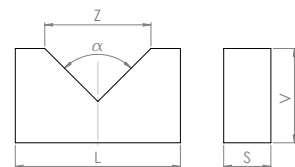

### SE DVĚMA ZÁŘEZY | 2 SLOTS | Z DWOMA WYCIĘCIAMI



CODE	L	S	V	Z	Z1	$\alpha$
1043-02-100	100	40	75	50	24	90°
1043-02-140	140	55	100	70	30	90°
1043-02-180	180	70	130	90	50	90°

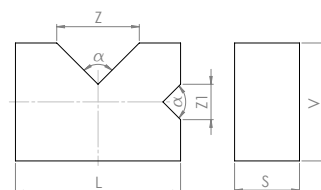

### SE ČTYŘMI ZÁŘEZY | 4 SLOTS | Z CZTEREMA WYCIĘCIAMI



CODE	L	S	V	Z	Z1	Z2	Z3	$\alpha$
1043-03-070	70	20	50	40	24	16	10	90°
1043-03-130	130	50	110	70	50	30	16	90°
1043-03-200	200	80	170	110	70	50	30	90°

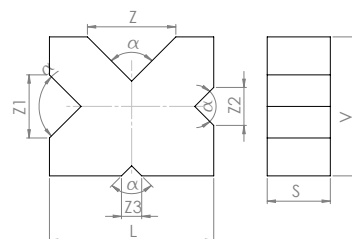

Na zakázku dodáváme i v provedení s magnetem.

We also supply version with magnets on request.

Dostarczamy również wykonane na zamówienie z magnesem.



### Podpěrky

Support Props for general use

Podpórka



3034



1042-50



3035 - 3037

CODE	výška   height   wysokość	nosnost   load cap.   pojemność	sestava   set   zestaw
3034	63 mm		1 hlava 1 head 1 główka
3035	80 mm	14 000 N	sada hrotů tips set
3036	145 mm	45 000 N	zestaw wskaźówek
3037	205 mm	70 000 N	
1042-50	podpěrka ke stolům - náhradní díl   Support Prop to the table - spare part   Popórka do stołów - części zamienne		

## Měrky | Slip & Pin Gauge Sets | Szczelinomierze

Základní ocelové měrky  
Steel Slip Gauge Sets  
Komplet płytek wzorcowych

**NEW  
LINE**



**I  
class**

CODE	ks   pcs   szt
1046-13-038	38
1046-13-047	47
1046-13-083	83
1046-13-087	87
1046-13-103	103
1046-13-112	112
1046-13-122	122

**0  
class**

CODE	ks   pcs   szt
1046-03-038	38
1046-03-047	47
1046-03-083	83
1046-03-087	87
1046-03-103	103
1046-03-112	112
1046-03-122	122

Sestava měrek | Gage Set | Zestawy :  
[http://www.kinexmeasuring.com/SESTAVA\\_MERЕК.pdf](http://www.kinexmeasuring.com/SESTAVA_MERЕК.pdf)

Základní keramické měrky  
Square Ceramic Gage Block Set  
Zestawy płytek wzorcowych ceramicznych

**NEW  
LINE**

**I  
class**



CODE	ks   pcs   szt
1050-13-032	32
1050-13-047	47
1050-13-087	87
1050-13-103	103

Válečkové měrky ocelové sada  
Steel Pin Gage Set  
Komplet wałeczków pomiarowych

**NEW  
LINE**



CODE		ks   pcs   szt	
1047-14-001	0,30 - 1,0/0,01 mm	71	2μm
1047-14-002	1,01 - 2,0/0,01 mm	100	2μm
1047-14-003	2,01 - 3,0/0,01 mm	100	2μm
1047-14-004	3,01 - 4,0/0,01 mm	100	2μm
1047-14-005	4,01 - 5,0/0,01 mm	100	2μm
1047-14-006	5,01 - 6,0/0,01 mm	100	2μm
1047-14-007	6,01 - 7,0/0,01 mm	100	2μm
1047-14-008	7,01 - 8,0/0,01 mm	100	2μm
1047-14-009	8,01 - 9,0/0,01 mm	100	2μm
1047-14-010	9,01 - 10,0/0,01 mm	100	2μm
1047-13-003	0,30 - 3,0/0,10 mm	28	2μm
1047-13-005	1,00 - 5,0/0,10 mm	41	2μm
1047-13-010	5,0 - 10,0/0,10 mm	51	2μm
1047-13-015	10,0 - 15,0/0,10 mm	51	2μm
1047-13-020	15,0 - 20,0/0,10 mm	51	2μm



## Lupy | Magnifying Glasses | Lupy

Brinellova lupa se dvěma čočkami 16mm  
Brinell Magnifying Glass 16 mm  
Lupa Brinella 16mm



CODE			↔
1094-02-008	x8	0,1 mm	0 - 10 mm
1094-02-010	x10	0,1 mm	0 - 10 mm
1094-02-012	x12	0,1 mm	0 - 10 mm
1094-02-015	x15	0,1 mm	0 - 10 mm

CODE			↔
1094-03-008	x8	0,1 mm	0 - 15 mm
1094-03-010	x10	0,1 mm	0 - 15 mm
1094-03-012	x12	0,1 mm	0 - 15 mm
1094-03-015	x15	0,1 mm	0 - 15 mm

Hodinářská lupa se skleněnou čočkou 24 mm  
Brinell Magnifying Glass 24 mm  
Lupa zegarmistrzowska 24mm



CODE	
1094-1	x3
1094-2	x4
1094-3	x6

Lupa s mm stupnicí  
Magnifier with mm scale  
Lupa ze skalą mm



CODE	
1094-04-010	x10

## Tvrdoměry | Hardness Gauges | Twardościomierze

Tvrdoměr Poldi - Tester  
Hardness Gauge Poldi tester  
Twardościomierz Poldi - Tester



tvrdost podle Brinella  
Brinell hardness  
twardość wg Brinella

CODE
1095-1

## Úhlooměry | Protractors | Kątomierze

Úhloměr digitální 0 - 360°

Digital Universal Bevel Protractor with magn. glass & rules, 0 - 360°  
Kątomierz elektroniczny 0 - 360°



CODE		
1093-20	0 - 360°	1' (0,01°)

Úhloměr s lupou a pravítky 0 - 360°

Universal Bevel Protractor with Magnifier and rulers 0 - 360°  
Kątomierz z lupą 0 - 360°

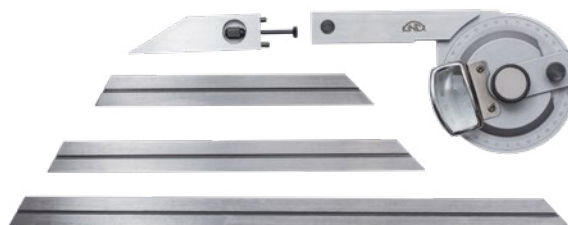

CODE		
1093	0 - 360°	5' (0,08°)

Úhloměr obloukový 180°

Protractor 0 - 180°

Kątomierz traserski 180°

Úhloměr obloukový 180° - NEREZ

Protractor 0 - 180° - STAINLESS STEEL

Kątomierz traserski 180° - STAL NIERDZEWNA

**INOX**

CODE	↔
1089-02-120	120x200 mm
1089-02-200	200x290 mm
1089-02-250	250x400 mm

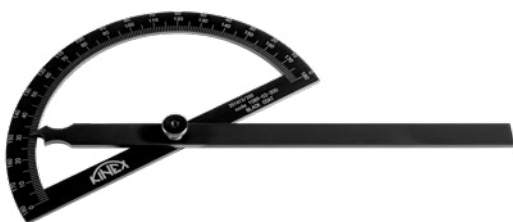

CODE	↔
1089-07-120	120x200 mm
1089-07-200	200x290 mm
1089-07-250	250x400 mm
1089-07-315	315x650 mm

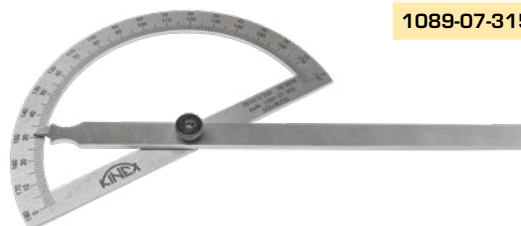

Úhloměr pro tesaře digitální

Digital Protractor for Carpenters

Kątomierz traserski elektroniczny



1092-02-268



1092-02-254

CODE	
1092-02-268	0,05°
1092-02-254	0,1°





## Měrky | Templates | Szczelinomierze

Měřidlo výšky dezénu pneumatik - digitální  
Digital Tyre Gauge  
Elektroniczny miernik wysokości bieżnika opon



### CODE



1119-10 0 - 25 mm / 0-1" ± 0,2 mm

Měrka ventilová - sada  
Feeler Gauge Set  
Szczelinomierz - zestaw



### CODE

ks | pcs | szt.

1130	0,02 - 0,2 mm	100 mm	10
1131	0,05 - 1 mm	100 mm	20
 1131-02-032	0,03 - 1 mm	100 mm	32
 1131-07-020	0,05 - 1 mm	100 mm	20
1132	0,05 - 1 mm	200 mm	20
 1132-02-013	0,05 - 1 mm	200 mm	13
1133	1 - 2 mm	200 mm	11

Měrka nemagnetická - sada (mosaz)  
Nonmagnetic Feeler Gauge Set (brass)  
Szczelinomierz niemagnetyczny - zestaw (mosiądz)



### CODE

ks | pcs | szt.

1129-1 0,05 - 1 mm 100 mm 20

Měrka radiusová - sada  
Radius Gauge Set  
Wzorce łuków - zestaw



### CODE

ks | pcs | szt.





1140	r 1 - 7 mm	34
1141	r 7,5 - 15 mm	32
1142	r 15,5 - 25 mm	30

Měrka závitová  
Screw Gauge Set  
Wzorce zarysu gwintu



### CODE

ks | pcs | szt.

1146	0,4 - 7 mm	20	Metric
1147	4 - 62 mm	28	Whitworth
1148	0,25 - 6 / 4 - 62 / 8 - 28 mm	58	M + W + G
 1148-02-014	10 - 40 mm	14	US
 1148-02-016	12 - 80 mm	16	UNF
 1148-02-020	4 - 26 mm	20	BSF
 1148-02-022	4 - 64 mm	22	UNC
 1148-02-030	4 - 42 mm	30	US

## Měrky | Templates | Szczelinomierze

Měrka ventilová v dóze  
Feeler Gauge Tape  
Szczelinomierz taśmowy



CODE			CODE		
1134-0,005/D	0,005 mm	5000x13 mm	1134-0,30/D	0,3 mm	5000x13 mm
1134-0,01/D	0,01 mm	5000x13 mm	1134-0,35/D	0,35 mm	5000x13 mm
1134-0,02/D	0,02 mm	5000x13 mm	1134-0,40/D	0,4 mm	5000x13 mm
1134-0,03/D	0,03 mm	5000x13 mm	1134-0,45/D	0,45 mm	5000x13 mm
1134-0,04/D	0,04 mm	5000x13 mm	1134-0,50/D	0,5 mm	5000x13 mm
1134-0,05/D	0,05 mm	5000x13 mm	1134-0,55/D	0,55 mm	5000x13 mm
1134-0,06/D	0,06 mm	5000x13 mm	1134-0,60/D	0,6 mm	5000x13 mm
1134-0,07/D	0,07 mm	5000x13 mm	1134-0,65/D	0,65 mm	5000x13 mm
1134-0,08/D	0,08 mm	5000x13 mm	1134-0,70/D	0,7 mm	5000x13 mm
1134-0,09/D	0,09 mm	5000x13 mm	1134-0,75/D	0,75 mm	5000x13 mm
1134-0,10/D	0,1 mm	5000x13 mm	1134-0,80/D	0,8 mm	5000x13 mm
1134-0,12/D	0,12 mm	5000x13 mm	1134-0,85/D	0,85 mm	5000x13 mm
1134-0,15/D	0,15 mm	5000x13 mm	1134-0,90/D	0,9 mm	5000x13 mm
1134-0,18/D	0,18 mm	5000x13 mm	1134-0,95/D	0,95 mm	5000x13 mm
1134-0,20/D	0,2 mm	5000x13 mm	1134-1,00/D	1 mm	5000x13 mm
1134-0,25/D	0,25 mm	5000x13 mm			

Šablona pro závit  
Thread Gauge  
Wzorce gwintów

INOX



1122



1123



1124



1126

CODE

1122	Whitworth 55°
1123	metrický   metric   metryczny 60°
1124	Trapéz 2 - 12 mm, 30°
1126	univerzální   universal   uniwersalny

Šablona na měření úhlů soustružnických nožů  
Template for measuring Turning Tools  
Szablon do mierzenia kątów noży w tokarce



CODE

1127

Měrka zbrošení vrtáku  
Twist Drill Grinding Gauge  
Szablon do wiertel



CODE

1121 40°, 50°, 60°, 70°, 80°, 90°, 100°, 110°, 120°, 130°, 140°

Kuželová měrka pro měření průměru  
Tapered Hole Gauge, flat  
Miernik stożkowy do pomiaru średnicy

NEW



CODE

1138-02-015 1-15

Šablona pro broušení vrtáku  
Template for Grinding Drill  
Szablon do ostrzenia wiertel



CODE

1125 55°, 60°



## Měrky | Templates | Szczelinomierze

Měrka koutových svarů, analog, nerez  
Welding Gauge  
Sposinierz analogowy, stal nierdzewna

INOX

### CODE

1120-07-020 60°,70°,80°,90° 0 - 20 mm 0,1 mm

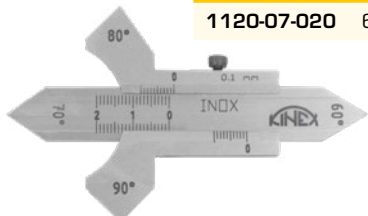

Měrka koutových svarů, digitalální  
Digital Welding Gauge  
Sposinierz digitalny

### CODE

1120-05-011 60°,70°,80°,90° 0 - 20 mm 0,01 mm



Měrka na svary - 3 stupnice  
Welding Gauge - 3 scales  
Miernik spawu - 3 skale

### CODE

1120-02-015

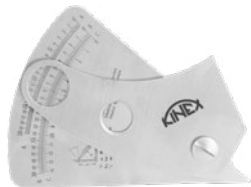

Měrka koutových svarů se zápornou stupnicí  
Welding Gauge with negative scale  
Sposinierz ze skalą ujemną

### CODE

1120-02-016



Měrka na svary - CAMBRIDGE  
Cambridge Welding Gauge  
Miernik spawu - CAMBRIDGE

### CODE

1120-02-013



Měrka koutových svarů  
Welding Gauge  
Sposinierz

### CODE

1120-02-010 50°, 60°, 115°, 120°

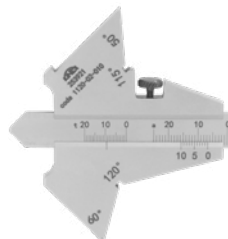

Šablona na koutové svary, 1-5  
Welding Gauge, 1 - 5  
Szablon spawu kątownego 1-5

### CODE

1120-02-012 1 - 5



Posuvné měřátko na měření zkosení hran 45°  
Caliper for chamfer 45°  
Suwmiarka do pomiaru fazowania 45°



### CODE

1128-02-007 0 - 70mm



Měrka svarová háková  
Pipe Welding Gauge  
Miernik spawu - hak

### CODE

1120-02-014



Měrka na měření průměru vrtáku  
Drill Gauge  
Miernik do pomiaru średnicy wiertła

### CODE

1125-02-013



## Stojánky | Stands | Podstawki

Stojánek magnetický UMAG  
Magnetic Stand UMAG  
Podstawka magnetyczna UMAG

Stojánek magnetický UMAG, papírový obal  
Magnetic Stand UMAG, paper wrapper  
Podstawka magnetyczna UMAG, opakow. papierowe

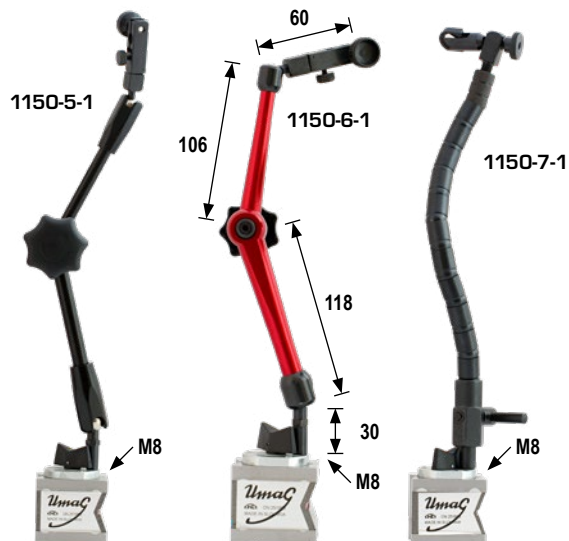
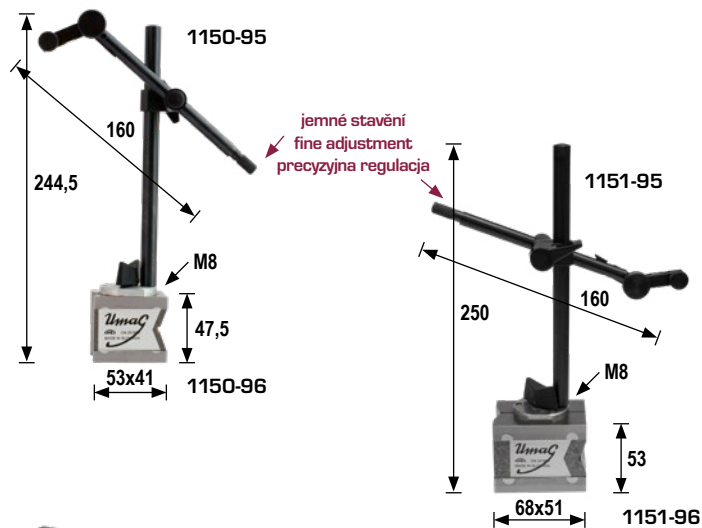

CODE	v papírovém obalu   in paper case   opakowanie AL	
1150	PN 25 1858.1	294N
1151	PN 25 1858.2	800N

CODE				
1150-5	velký kloub   velký klb   duży przegub	160 mm	294 N	
1150-6	ekonomický   ekonomic   ekonomiczny	160 mm	294 N	
1150-7	ohybný kloub   ohybný klb   elastyczny przegub	360 mm	294 N	



CODE	v luxusním AL obalu   in luxury AL case   luksusowe AL opakowanie	
1150-1	PN 25 1858.1	294N
1151-1	PN 25 1858.2	800N

Stojánek magnetický UMAG - PROFI, papírový obal  
Magnetic Stand UMAG - PROFI, paper wrapper  
Podstawka magnetyczna UMAG - PROFI, opakow. papierowe

**NEW  
LINE**



CODE	
1150-61	294 N
1151-61	800 N

1150-61  
1151-61



## Stojánky | Stands | Podstawki

Měřicí granitový stojánek  
Granite Stand with Arm  
Precyzyjny stolik pomiarowy

**NEW  
LINE**

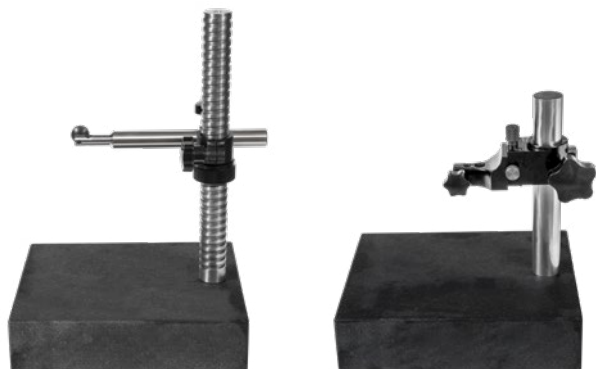

1150-04-250

1150-05-250

**CODE**

1150-04-250 250x200x65 mm

1150-05-250 250x200x65 mm

Měřicí stůl s jemným stavěním  
Granite Stand with Fine Adjustment  
Precyzyjny stolik pomiarowy z regulowanym remieniem

**NEW  
LINE**



1150-07-150

**CODE**

1150-07-150 150x150 mm

Stojánek  
Stand  
Podstawka



1152

1153

**CODE**

1152 upínací | clamping | zaciskanie  $\varnothing$  8 mm PN 25 1867 180 mm

1153 upínací | clamping | zaciskanie  $\varnothing$  8 mm PN 25 1857 180 mm

Stolní odmagnetovač - demagnetizér  
Demagnetizer  
Demagnetyzer stołowy



**CODE**

1154-02-190 190x120x90 mm 80W/220V

1154-02-210 210x152x105 mm 150W/220V

Stojánek na mikrometry  
Holder for Micrometer  
Podstawka dla mikrometrów



1160

1160-02-117

**CODE**

1160

1160-02-117

## Úchylkoměry | Indicators | Czujniki

Úchylkoměr číselníkový TOP QUALITY (vhodný pro kalibrace)  
Dial Indicator TOP QUALITY (recommended for calibration)  
Czujnik zegarowy - TOP QUALITY (nadaje się do kalibracji)

0,01

**DIN**  
878

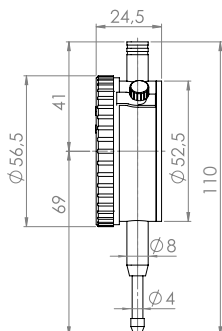

CODE		
1155-02-110	0 - 10 mm	0,01 mm

Úchylkoměr číselníkový  
Dial Indicator  
Czujnik zegarowy

0,001

0,01

**DIN**  
878

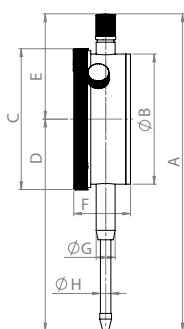

CODE			A	B	C	D	E	F	G	H
1155-02-010	0 - 10 mm	0,01 mm	110	52,5	56,5	69	41	24,5	8	4
1155-02-001	0 - 1 mm	0,001 mm	92	50	53	56	36	22	8	4
1155-02-025	0 - 25 mm	0,01 mm	124,5	55	59,5	84,5	40	24	8	4,4
1155-02-030	0 - 30 mm	0,01 mm	134	55	59,5	89,5	44,5	24	8	4,4
1155-02-005	0 - 5 mm	0,01 mm	83,5	37	41	50	33,5	21	8	4,4

Úchylkoměr číselníkový - s uchycením  
Dial Indicator with lug  
Czujnik zegarowy - z mocowaniem

0,01

**DIN**  
878

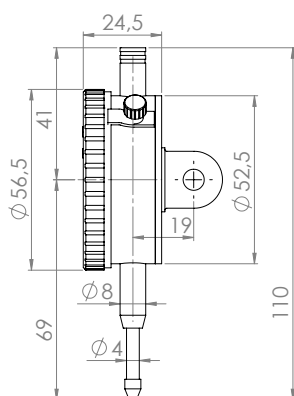

CODE		
1155-02-410	0 - 10mm	0,01 mm

SHOCK PROOF - odolný proti nárazu  
SHOCK PROOF - shock-proof  
SHOCK PROOF - wstrząsoodporny

CODE		
1155-02-710	0 - 10 mm	0,01 mm



## Úchylkoměry | Indicators | Czujniki

Úchylkoměr číselníkový digitální ABSOLUTE ZERO, MAX/MIN, vhodné pro kalibrace  
 Digital Indicator ABSOLUTE ZERO, MAX/MIN (recommended for calibration)  
 Czujnik zegarowy elektroniczny ABSOLUTE ZERO, MAX/MIN, nadaje się do kalibracji



0,001

0,01



1155-05-010

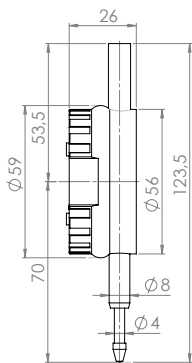

1155-05-001

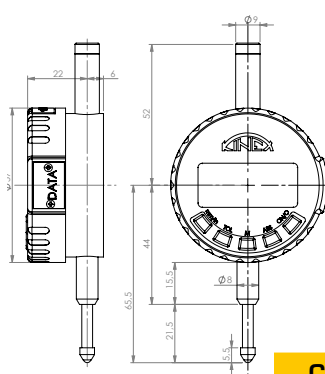

Dodáváno včetně protokolu o přeměření.  
 Supplied with the Measuring Protocol.  
 Dostarczamy wraz z protokołem o  
 przemierzeniu.

CODE	— —	D	
1155-05-010	0 - 12,7mm	60	0,01 mm M 2,5
1155-05-001	0 - 12,7mm	60	0,001 mm M 2,5



1155-052-001

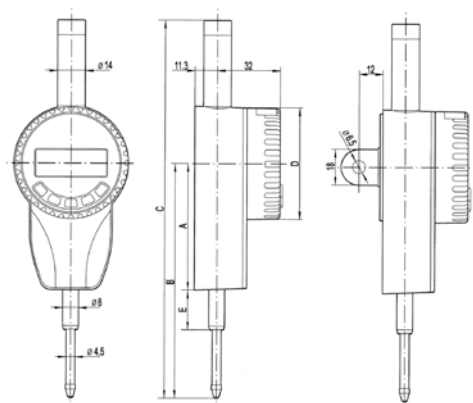

1155-35-001

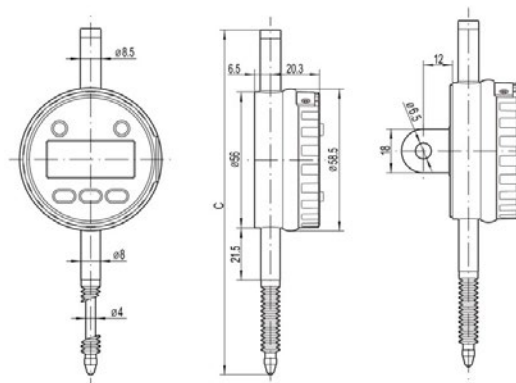

CODE	— —	B	C	ø	
1155-35-010	0 - 12,7 mm	88,5	142,0	8 mm	0,01 mm M 2,5
1155-35-001	0 - 12,7 mm	88,5	140,5	8 mm	0,001 mm M 2,5

Interface pro připojení k PC  
 PC Interface  
 Interface do połączenia z komputerem



CODE	— —	ø	A	B	C	
1155-051-001	0 - 25 mm	8 mm	63	118	190	0,001 mm M 2,5
1155-052-010	0 - 50 mm	8 mm	105	184	282	0,01 mm M 2,5
1155-052-001	0 - 50 mm	8 mm	105	184	282	0,001 mm M 2,5

CODE	
6040-05-9001	interface
6040-05-901	nožní spínač   Footswitch   przelącznik nożny
6040-05-902	kabel   cable   kabel

## Úchylkoměry | Indicators | Czujniki

Úchylkoměr číselníkový digitální  
Digital Indicator, metal housing  
Czujnik zegarowy elektroniczny

0,001

0,01

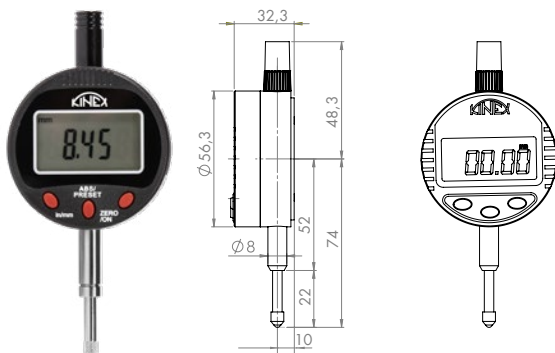

CODE			
1155-25-010	0 - 12,7 mm	0,01 mm	M 2,5
1155-25-001	0 - 12,7 mm	0,001 mm	M 2,5

Úchylkoměr číselníkový páčkový  
Dial Test Indicator  
Czujnik zegarowy - Diatest

0,002

0,01

DIN  
2270

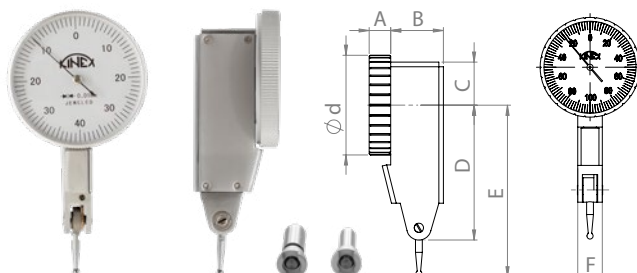

### HORIZONTÁLNÍ | HORIZONTAL | POZIOMY

CODE			d	A	B	C	D	E	F
1156-02-010	± 0,8 mm	0,01mm	39	7,5	17	14	44	56	8
1156-02-102	± 0,2 mm	0,002mm	32,5	7	17	14	44	56	8
1156-02-222	± 0,8 mm	0,01mm	39	7,5	17	14	44	56	8

1156-02-222 - karbidový hrot | carbide point | trzpień węglkowy



### VERTIKÁLNÍ | VERTICAL | PIONOWY

CODE			d	A	B	D	E
1156-02-110	± 0,8 mm	0,01mm	39	6	16	57	75

Měřicí můstek k digitálním úchylkoměrům  
Measuring Bridge for Digital Digital Indicators  
Mostek pomiarowy dla czujnika zegarowego (tylko elektroniczny)

Náhradní dotyky k úchylkoměrům  
Probe Tips  
Zestawy wymiennych końcówek do czujników

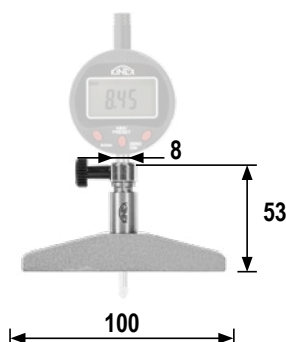

CODE
1155-00-100



CODE		
1155-7	M2,5 mm	sada 22 ks set 22 pcs zestaw 22 szt.





## Hmatadla | Internal & External Calipers | Cyrkle

Hmatadlo vnější  
External Caliper  
Macka zewnętrzná

ČSN  
25 1210



CODE		
2001	0 - 250 mm	150 mm
2002	0 - 340 mm	200 mm
2002-1	0 - 250 mm	250 mm
2003	0 - 510 mm	300 mm

Hmatadlo vnější  
External Caliper  
Macka zewnętrzná

ČSN  
25 1212



CODE		
2006	0 - 120 mm	150 mm
2007	0 - 165 mm	200 mm
2008	0 - 205 mm	250 mm
2009	0 - 250 mm	300 mm
2010	0 - 350 mm	500 mm

Hmatadlo vnitřní  
Internal Caliper  
Macka wewnętrzná sprężynowa

ČSN  
25 1215



CODE		
2012	20 - 300 mm	150 mm
2013	25 - 400 mm	200 mm
2014	30 - 600 mm	300 mm

Hmatadlo vnitřní  
Internal Caliper  
Macka wewnętrzná sprężynowa

ČSN  
25 1217



CODE		
2016	10 - 130 mm	150 mm
2017	12 - 165 mm	200 mm
2018	12 - 205 mm	250 mm
2019	12 - 250 mm	300 mm

## Hloubkoměry | Depth Gauges | Głębokościomierze

Hloubkoměr bez nosu  
Vernier Depth Gauge  
Głębokościomierz bez nosa

0,02

ČSN  
25 1280

DIN  
862

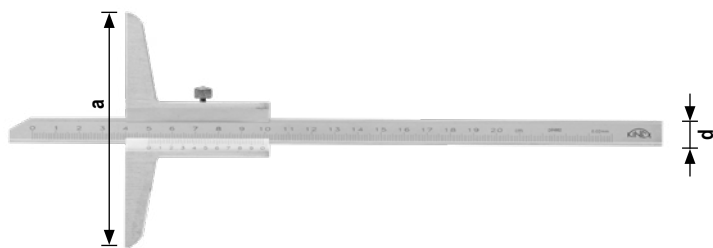

CODE		a [mm]	d [mm]	
2034-02-150	0 - 150 mm	100	11	0,02 mm
2034-02-200	0 - 200 mm	100	11	0,02 mm
2034-02-300	0 - 300 mm	100	11	0,02 mm
2034-02-500	0 - 500 mm	125	11	0,02 mm

Hloubkoměr s nosem  
Vernier Depth Gauge with Nose  
Głębokościomierz z nosem

0,02

ČSN  
25 1282

DIN  
862

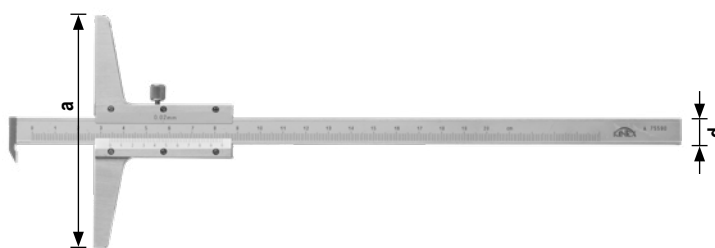

CODE		a [mm]	d [mm]	
2040-02-150	0 - 150 mm	100	11	0,02 mm
2040-02-200	0 - 200 mm	100	11	0,02 mm
2040-02-250	0 - 250 mm	100	11	0,02 mm
2040-02-300	0 - 300 mm	100	11	0,02 mm
2040-02-500	0 - 500 mm	100	11	0,02 mm

## Hloubkoměry | Depth Gauges | Głębokościomierze

Hloubkoměr digitální bez nosu  
Digital Depth Gauge  
Głębokościomierz elektroniczny bez nosa

0,01

**DIN**  
862



CODE	Range [mm]	a [mm]	b [mm]	d [mm]	Resolution
2050-05-150	0 - 150 mm	100	4	14	0,01 mm
2050-05-200	0 - 200 mm	100	4	14	0,01 mm
2050-05-300	0 - 300 mm	100	4	14	0,01 mm
2050-05-500	0 - 500 mm	120	7	15	0,01 mm
2050-05-600	0 - 600 mm	120	7	15	0,01 mm
2050-05-800	0 - 800 mm	150	7	18	0,01 mm

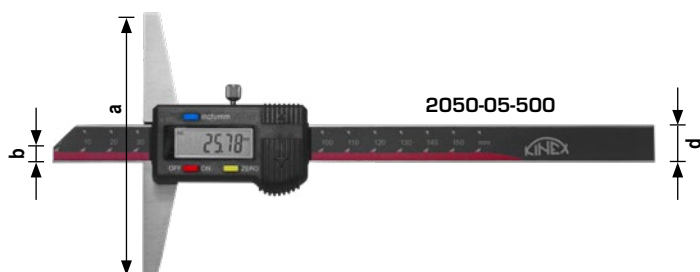

**NEW LINE**

CODE	Range [mm]	a [mm]	b [mm]	d [mm]	Resolution
2050-25-150	0 - 150 mm	100	4	14	0,01 mm
2050-25-150	0 - 200 mm	100	4	14	0,01 mm
2050-25-150	0 - 300 mm	100	4	14	0,01 mm



S JEHLOU | WITH NEEDLE | Z IGLĄ

**NEW LINE**

CODE	Range [mm]	a [mm]	b [mm]	d [mm]	Resolution
2052-05-150	0 - 150 mm	100	4	14	0,01 mm

Hloubkoměr digitální s nose  
Digital Depth Gauge  
Głębokościomierz elektroniczny z nose

0,01

**DIN**  
862

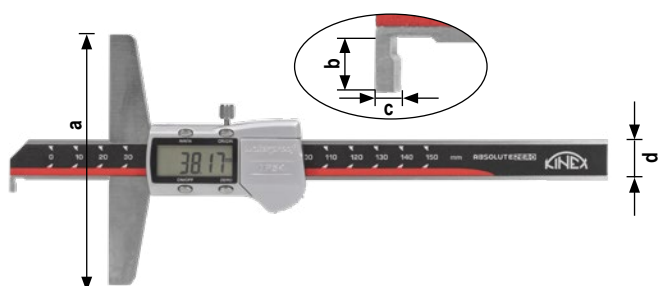

CODE	Range [mm]	a [mm]	b [mm]	c [mm]	d [mm]	Resolution
2051-05-150	0 - 150 mm	100	5	2	14	0,01 mm
2051-05-200	0 - 200 mm	100	5	2	14	0,01 mm
2051-05-300	0 - 300 mm	100	5	2	14	0,01 mm
2051-05-500	0 - 500 mm	120	8	3	15	0,01 mm



## Kružidla | Spring Bow Dividers | Cyrkle

Kružidlo s pružinou  
Spring Bow Divider  
Cyrkiel sprężynowy

ČSN  
25 5170

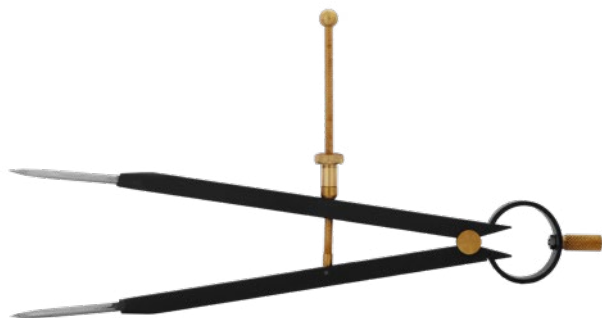

CODE		
2070-02-150	6 - 200 mm	150 mm
2070-02-200	10 - 300 mm	200 mm
2070-02-250	10 - 350 mm	250 mm
2070-02-300	10 - 450 mm	300 mm

Kružidlo bez mm dělení  
Marking Gauge without mm Scale and Fine Adjustment  
Cyrkiel nastawny



CODE		
2074	25 - 470 mm	500 mm
2075	25 - 960 mm	1000 mm
2074-1	prodloužení   extension   przedłużenie	500 mm
2075-1	prodloužení   extension   przedłużenie	1000 mm

Kružidlo ploché s mm dělením a jemným stavěním  
Beam Trammel with 0,1mm graduation, Fine Adjustment  
Cyrkiel nastawny z podziałą i precyzerem

DIN  
862



CODE		
2078	500 mm	0,1 mm
2078-1	1000 mm	0,1 mm
2078-2	1500 mm	0,1 mm
2078-3	2000 mm	0,1 mm



Nádrh  
Surface Gauge  
Rysik słupkowy traserski

ČSN  
25 5315



CODE	
3001	250 mm
3002	400 mm

## Výškoměry | Height Gauges | Wysokościomierze

Výškoměr analogový  
Height Gauge  
Wysokościomierz suwmiarkowy

0,02

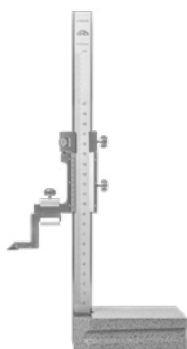

CODE	
3014-02-020	0 - 200 mm
3014-02-030	0 - 300 mm
3014-02-050	0 - 500 mm
3014-02-100	0 - 1000 mm

Výškoměr digitální  
Digital Height Gauge  
Wysokościomierz suwmiarkowy z odczytem cyfrowým

0,01



CODE	
3022-05-020	0 - 200 mm
3022-05-030	0 - 300 mm
3022-05-050	0 - 500 mm
3022-05-060	0 - 600 mm
3022-05-080	0 - 800 mm
3022-05-100	0 - 1000 mm

Výškoměr digitální s dvojitým ramenem  
Digital Double Column Height Gauge  
Wysokościomierz elektroniczny kolumnowy

0,01



CODE	
3020-02-030	0 - 300 mm
3020-02-050	0 - 500 mm
3020-02-060	0 - 600 mm



## Rýsovací jehly a tužky | Scribers | Rysiki i ołówki

Rýsovací jehly  
Scribers  
Rysiki - węglkowe



CODE		ø	↔
3025	rovná   straight   równa	ČSN 25 5340.11	5 mm 150 mm
3026	zahnutá   bent   zakrzywiona	ČSN 25 5340.21	5 mm 200 mm
3026-30	celokarbidová   fully carbide   monolit		4 mm 160 mm

Rýsovací tužky  
Drawing Pencils  
Ołówki - węglkowe



CODE		↔
3025-2	s karbidovým hrotem with carbide tip z koňcôwką węglkową	150 mm
3025-3	s vysouvacím karbidovým hrotem, gum. držadlo with extendable carbide tip, rubber grip z koňcôwką węglkową i gumovým uchwytem	140 mm
3025-4	s karbidovým oboustranným hrotem a dűlčikem carbide two-sided point, punch z obustronną koňcôwką węglkową	140 mm

Tužka rýsovací na sklo a plech 3263  
Ceruzka rysowacie na sklo, typ 3263/180mm  
Ołówek do trasowania na szkle i blachach 3263



CODE	typ	↔
9038	3262	175 mm

Tužka tesařská  
Carpenter Pencil  
Ołówek stolarski



CODE	tvrdost   tvrdost   twardość	typ	↔
9030	1	1536	175 mm
9031	2	1536	175 mm
9033	2	1537	250 mm

Tužka rýsovací na kámen  
Pencil for Stone  
Ołówek do trasowania kamienia



CODE	typ	↔
9035	1536	175 mm

## Vratidla závitníků a závitových oček | Tap Wrenches | Pokrętła do gwint. i oprawy do narzynek

Vratidlo na závitníky pro čtyřhran  
Tap Holder  
Pokrętła do gwintowników



CODE			#
3040-02-045	2,00 - 4,50 mm	M2 - M7	1
3047-02-710	2,50 - 7,10 mm	M3 - M12	
3045-02-630	3,15 - 6,30 mm	M4 - M11	2
3042-02-900	3,55 - 9,00 mm	M6 - M14	3
3044-02-160	5,60 - 16,00 mm	M9 - M27	4
3046-02-180	6,00 - 18,00 mm	M10 - M30	
3048-02-315	14,00 - 31,50 mm	M24 - M52	5

Vratidlo na závitníky pro čtyřhran  
Tap Holder  
Pokrętła do gwintowników

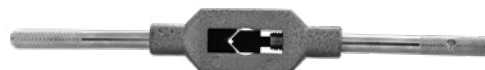

CODE	
3039-02-130	M1 - M8
3039-02-188	M3 - M10
3039-02-280	M4 - M12
3039-02-375	M5 - M20
3039-02-500	M9 - M27
3039-02-750	M13 - M52

Držák na závitová očka  
Die Holder  
Oprawa do narzynek



CODE		
3052	16 mm	M1 - M2,5
3053	20 mm	M3 - M6
3054	25 mm	M7 - M9
3055	30 mm	M10 - M11
3056	38 mm	M12 - M15

CODE		
3057	45 mm	M16 - M20
3058	55 mm	M22 - M26
3059	65 mm	M27 - M36
3059-1	75 mm	M39 - M42
3060	90 mm	M45 - M52

## Nástavce závitníků | Tap Extensions | Przedłużacze gwintowników

Nástavce závitníků  
Tap Extension  
Przedłużacze gwintowników



CODE		↔
3049-06-315	3,15	90 mm
3049-06-355	3,55	95 mm
3049-06-400	4,00	100 mm
3049-06-500	5,00	110 mm
3049-06-560	5,60	115 mm
3049-06-620	6,20	125 mm
3049-06-630	6,30	120 mm
3049-06-710	7,10	125 mm
3049-06-900	9,00	135 mm



CODE		↔
3049-08-210	2,10	60 mm
3049-08-240	2,40	70 mm
3049-08-270	2,70	80 mm
3049-08-300	3,00	80 mm
3049-08-340	3,40	90 mm
3049-08-380	3,80	100 mm
3049-08-430	4,30	105 mm
3049-08-490	4,90	110 mm
3049-08-550	4,90	110 mm
3049-08-620	6,20	120 mm
3049-08-800	8,00	125 mm
3049-08-110	11,00	150 mm
3049-08-120	12,00	155 mm
3049-08-130	13,00	165 mm



## Úhelníky | Squares | Kątowniki

Úhelník přesný, plochý  
Precision Flat Square  
Kątownik precyzyjny płaski

**DIN**  
875

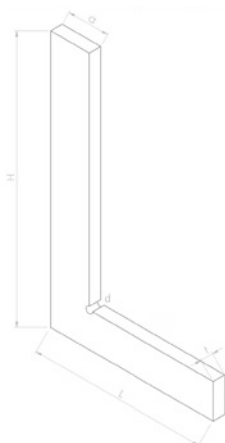

**0**  
class

CODE	H [mm]	L [mm]	a [mm]	t [mm]
4033-02-007	75	50	17	6
4033-02-010	100	70	21	6
4033-02-015	150	100	26	8
4033-02-020	200	130	26	8
4033-02-025	250	160	31	8
4033-02-030	300	200	32	8
4033-02-040	400	250	40	8
4033-02-050	500	330	50	10
4033-02-060	600	400	50	10
4033-02-075	750	500	60	12
4033-02-100	1000	660	70	15

**I**  
class

CODE	H [mm]	L [mm]	a [mm]	t [mm]
4033-12-007	75	50	17	6
4033-12-010	100	70	21	6
4033-12-015	150	100	26	8
4033-12-020	200	130	26	8
4033-12-025	250	160	31	8
4033-12-030	300	200	32	8
4033-12-040	400	250	40	8
4033-12-050	500	330	50(60)	10(12)
4033-12-060	600	400	50(60)	10(12)
4033-12-075	750	500	50(60)	10(12)
4033-12-100	1000	660	50(60)	10(12)

**II**  
class

CODE	H [mm]	L [mm]	a [mm]	t [mm]
4033-22-007	75	50	17	6
4033-22-010	100	70	21	6
4033-22-015	150	100	26	8
4033-22-020	200	130	26	8
4033-22-025	250	160	31	8
4033-22-030	300	200	32	8
4033-22-040	400	200	40	8
4033-22-050	500	250	50	10(12)
4033-22-060	600	300	50	10(12)
4033-22-075	750	375	50	10(12)
4033-22-100	1000	500	50	10(12)
4033-22-150	1500	750	60	12
4033-22-200	2000	1000	60	12
4033-22-250	2500	1250	60	12

## Úhelníky | Squares | Kątowniki

Úhelník přesný, příložný  
Precision Try Square  
Kątownik precyzyjny ze stopką

**DIN**  
875



**0**  
class

CODE	H [mm]	L [mm]	a [mm]	t [mm]	b [mm]	c [mm]
4034-02-007	75	50	17	6	16	6
4034-02-010	100	70	21	6	16	6
4034-02-015	150	100	26	8	20	8
4034-02-020	200	130	26	8	20	8
4034-02-025	250	160	31	8	25	8
4034-02-030	300	200	32	8	30	8
4034-02-040	400	250	40	8	30	8
4034-02-050	500	330	50	10	40	8
4034-02-060	600	400	50	10	40	8
4034-02-075	750	500	60	12	40	8
4034-02-100	1000	660	70	15	40	8

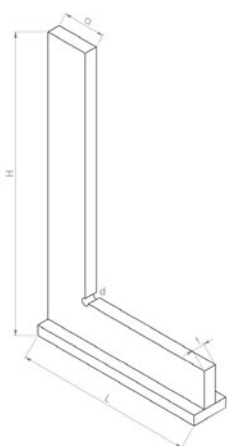

**I**  
class

CODE	H [mm]	L [mm]	a [mm]	t [mm]	b [mm]	c [mm]
4034-12-007	75	50	17	6	16	6
4034-12-010	100	70	21	6	16	6
4034-12-015	150	100	26	8	20	8
4034-12-020	200	130	26	8	20	8
4034-12-025	250	160	31	8	25	8
4034-12-030	300	200	32	8	30	8
4034-12-040	400	250	40	8	30	8
4034-12-050	500	330	50 (60)	10 (12)	40	8
4034-12-060	600	400	50 (60)	10 (12)	40	8
4034-12-075	750	500	50 (60)	10 (12)	40	8
4034-12-100	1000	660	50 (60)	10 (12)	40	8

**II**  
class

CODE	H [mm]	L [mm]	a [mm]	t [mm]	b [mm]	c [mm]
4034-22-007	75	50	17	6	16	6
4034-22-010	100	70	21	6	16	6
4034-22-015	150	100	26	8	20	6
4034-22-020	200	130	26	8	20	6
4034-22-025	250	160	31	8	25	8
4034-22-030	300	200	32	8	30	8
4034-22-040	400	200	40	8	30	8
4034-22-050	500	250	50	10 (12)	40	8
4034-22-060	600	300	50	10 (12)	40	8
4034-22-075	750	375	50	10 (12)	40	8
4034-22-100	1000	500	50	10 (12)	40	8
4034-22-150	1500	750	60	12	50	10
4034-22-200	2000	1000	60	12	50	10
4034-22-250	2500	1250	60	12	50	10





## Úhelníky | Squares | Kątowniki

Úhelník přesný, plochý - NEREZ

Precision Flat Square - Stainless steel

Kątownik precyzyjny płaski - STAL NIERDZEWNA

INOX

DIN  
875

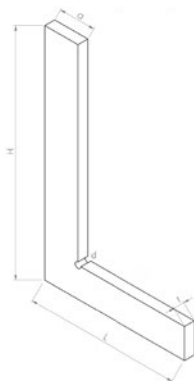

**0**  
class

CODE	H [mm]	L [mm]	a [mm]	t [mm]
4033-07-007	75	50	17	6
4033-07-010	100	70	21	6
4033-07-015	150	100	26	8
4033-07-020	200	130	26	8
4033-07-025	250	165	31	8
4033-07-030	300	200	32	8
4033-07-040	400	265	40	8
4033-07-050	500	330	50	10

**I**  
class

CODE	H [mm]	L [mm]	a [mm]	t [mm]
4033-17-007	75	50	17	6
4033-17-010	100	70	21	6
4033-17-015	150	100	26	8
4033-17-020	200	130	26	8
4033-17-025	250	165	31	8
4033-17-030	300	200	32	8
4033-17-040	400	265	40	8
4033-17-050	500	330	50	10 (12)

DALŠÍ ROZMĚRY NA ZAKÁZKU  
OTHER SIZES ON REQUEST  
INNE WYMIARY NA ZAMÓWIENIE

Úhelník přesný, příložný - NEREZ

Precision Try Square - Stainless steel

Kątownik precyzyjny ze stopką - STAL NIERDZEWNA

INOX

DIN  
875

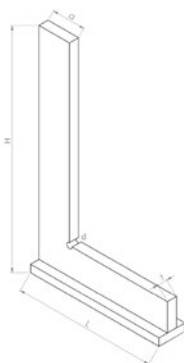

**0**  
class

CODE	H [mm]	L [mm]	a [mm]	t [mm]
4034-07-007	75	50	17	6
4034-07-010	100	70	21	6
4034-07-015	150	100	26	8
4034-07-020	200	130	26	8
4034-07-025	250	165	31	8
4034-07-030	300	200	32	8
4034-07-040	400	265	40	8
4034-07-050	500	330	50	10

**I**  
class

CODE	H [mm]	L [mm]	a [mm]	t [mm]
4034-17-007	75	50	17	6
4034-17-010	100	70	21	6
4034-17-015	150	100	26	8
4034-17-020	200	130	26	8
4034-17-025	250	165	31	8
4034-17-030	300	200	32	8
4034-17-040	400	265	40	8
4034-17-050	500	330	50	10 (12)

DALŠÍ ROZMĚRY NA ZAKÁZKU  
OTHER SIZES ON REQUEST  
INNE WYMIARY NA ZAMÓWIENIE

## Úhelníky | Squares | Kątowniki

Úhelník příložený přesný - NOVÝ TYP

Precision Universal Square

Kątownik precyzyjny ze stopką - Nowy typ

**DIN**  
875

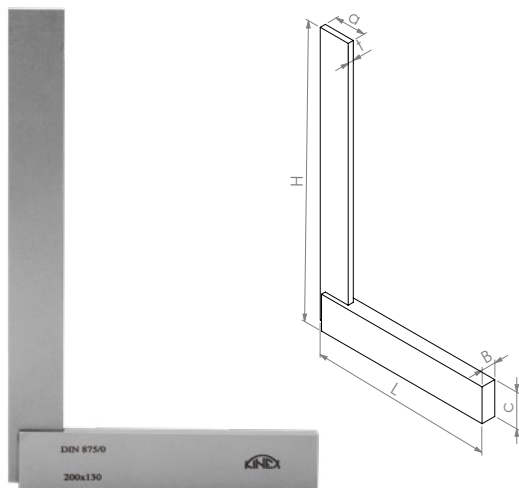

**0**  
class

CODE	a [mm]	t [mm]	C [mm]	B [mm]	H [mm]	L [mm]
4026-02-006	16	4	16	10	60	40
4026-02-007	16	4	16	10	75	50
4026-02-010	16	4	20	10	100	70
4026-02-015	20	4	25	10	150	100
4026-02-020	22	4	25	10	200	130
4026-02-025	23	4	26	12	250	165
4026-02-030	24	4	27	12	300	200
4026-02-040	26	4	32	16	400	265
4026-02-050	30 - 32	4	32	16	500	330

**I**  
class

CODE	a [mm]	t [mm]	C [mm]	B [mm]	H [mm]	L [mm]
4026-12-006	16	4	16	10	60	40
4026-12-007	16	4	16	10	75	50
4026-12-010	16	4	20	10	100	70
4026-12-015	20	4	25	10	150	100
4026-12-020	22	4	25	10	200	130
4026-12-025	23	4	26	12	250	165
4026-12-030	24	4	27	12	300	200
4026-12-040	26	4	32	16	400	265
4026-12-050	30 - 32	4	32	16	500	330
4026-12-060	30 - 32	4	32	16	600	400
4026-12-154	sada   set   zestaw 60, 75, 100, 150					
4026-12-250	sada   set   zestaw 100, 150, 200, 250					

Ultralehký úhelník přesný, příložený KINEX ICONIC Labo (carbon/titan)

Ultralight Precise Square ICONIC Labo (carbon/titan)

Ultralekki kątownik KINEX ICONIC Labo (carbon/titan)

**DIN**  
875



VHODNÝ PRO ROBOTICKÁ PRACOVISTĚ  
SUITABLE FOR ROBOTIC WORKPLACES  
NADAJE SIĘ DO ZAUTOMATYZOWANEJ STACJI ROBOCZEJ



CODE	a [mm]	t [mm]	C [mm]	B [mm]	H [mm]	L [mm]
4026-28-006	12x1,5	1,5	60	40	40	40



## Úhelníky | Squares | Kątowniki

Úhelník přesný plochý typ "Au"  
Precision Flat Square "Au"  
Kątownik precyzyjny płaski typ "Au"

ČSN  
25 5103

DIN  
875

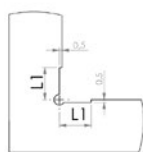
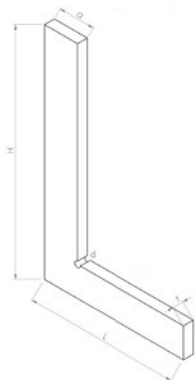

ČSN  
I

DIN  
II

CODE	H [mm]	L [mm]	a [mm]	t [mm]	L1 [mm]
4034	63	40	17	6	-
4035	100	63	21	6	-
4036	160	100	26	8	-
4037	250	160	31	8	-
4038	400	250	40	8	18
4039	630	400	50	12	22
4040	750	375	50	10 (12)	22
4041	1000	500	50	10 (12)	22
4042	1500	750	60	12	-
4043	2000	1000	60	12	-

Úhelník přesný plochý kalený typ "A"  
Precision Flat Square Hardened "A"  
Kątownik precyzyjny płaski hartowany typu "A"

ČSN  
25 5103

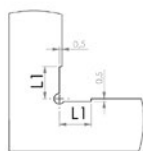
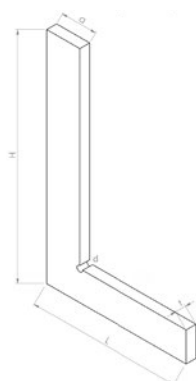

ČSN  
I

CODE	H [mm]	L [mm]	a [mm]	t [mm]	L1 [mm]
4045	63	40	17	6	-
4046	100	63	21	6	-
4047	160	100	26	8	-
4048	250	160	31	8	-
4049	400	250	40	8	18

Úhelník přesný příložný typ "Bu"  
Precision Try Square "Bu"  
Kątownik precyzyjny ze stopką typu "Bu"

DIN  
875

ČSN  
25 5103

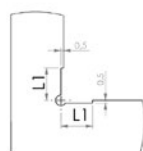
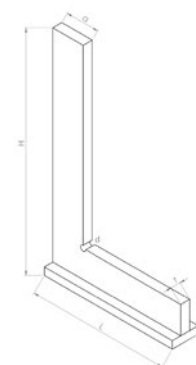

ČSN  
II

DIN  
II

CODE	H [mm]	L [mm]	a [mm]	t [mm]	L1 [mm]
4051	63	40	17	6	-
4052	100	63	21	6	-
4053	160	100	26	8	-
4054	250	160	31	8	-
4055	400	250	40	8	18
4056	630	400	50	12	22
4057	750	375	50	10 (12)	22
4057-1	1000	500	50	10 (12)	22
4057-2	1500	750	60	12	-
4057-3	2000	1000	60	12	-

## Úhelníky | Squares | Kątowniki

Úhelník přesný příložný kalený typ "B"  
Precision Try Square Hardened "B"  
Kątownik precyzyjny ze stopką hartowany typu "B"

**ČSN**  
25 5103

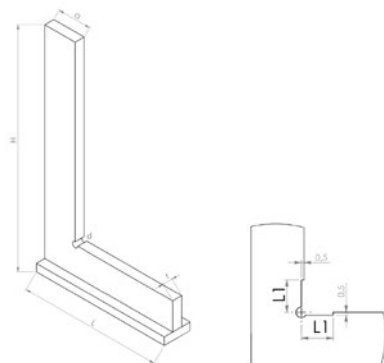

**ČSN**  
II

CODE	H [mm]	L [mm]	a [mm]	t [mm]	L1 [mm]
4058	63	40	17	6	-
4059	100	63	21	6	-
4060	160	100	26	8	-
4061	250	160	31	8	-
4061-1	400	250	40	8	18

Úhelník zámečnický plochý  
Flat Square  
Kątownik płaski

**PN**  
25 5120

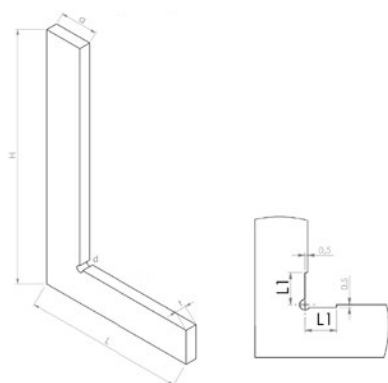

CODE	H [mm]	L [mm]	a [mm]	t [mm]	L1 [mm]
4010	100	63	17	4	-
4011	160	100	26	5	-
4012	250	160	26	5	-
4013	400	250	32	6	18
4014	630	400	40	8	22
4015	750	375	40	8	22
4016	1000	500	40	8	22

Úhelník zámečnický příložný  
Try Square  
Kątownik ze stopką

**PN**  
25 5124

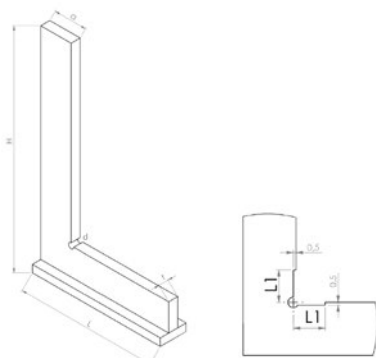

CODE	H [mm]	L [mm]	a [mm]	t [mm]	L1 [mm]
4020	100	63	17	4	-
4021	160	100	26	5	-
4022	250	160	26	5	-
4023	400	250	32	6	18
4024	630	400	40	8	22
4025	750	375	40	8	22
4025-1	1000	500	40	8	22



## Úhelníky | Squares | Kątowniki

Úhelník s pružným ramenem a mm dělením  
Flexible Precision Square with mm graduation  
Kątownik z elastycznym ramieniem i mm skalą

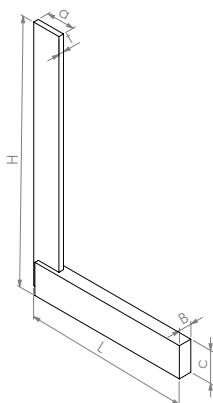
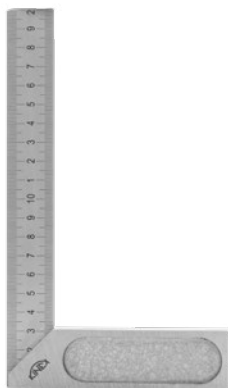

CODE	a [mm]	t [mm]	c [mm]	B [mm]	↔
4031	30	1	15	5	200x120 mm
4032	30	1	15	5	250x150 mm

Úhelník BLACK COAT s mm dělením  
Square BLACK COAT with mm graduation  
Kątownik BLACK COAT - skala mm

AI

STEEL

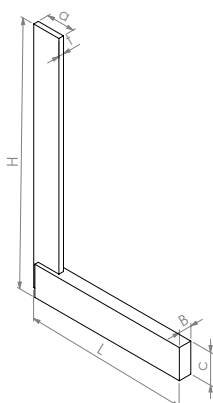
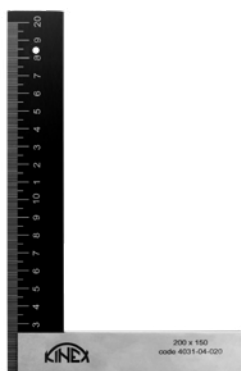

hliník/ocel | hliník/ocel' | aluminium/stal

CODE	a [mm]	t [mm]	c [mm]	B [mm]	↔
4031-03-020	32	5	25	10	200x130 mm
4031-03-025	32	5	26	12	250x165 mm
4031-03-030	32	5	27	12	300x200 mm

Úhelník AL s mm dělením  
Square AL with mm graduation  
Kątownik AL - skala mm



Magnetický úhelník na sváření  
Magnetic Welding Clamp  
Kątownik do spawania



CODE	↔
4031-04-025	250x140 mm
4031-04-030	300x170 mm
4031-04-040	400x200 mm



CODE	↔
4064-08-010	100 x 65 30, 45, 60, 75, 90°
4064-08-011	110 x 95 30, 90, 135°

## Úhelníky | Squares | Kątowniki

Úhelník nožový - přesný kalený, typ E  
Precision Knife Edge Square "E"  
Kątownik krawędziowy - prec. hartowany, typ E

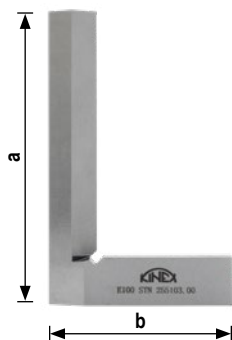

CODE		a [mm]	b [mm]
4001	7x11 / 11x11 mm	63	35
4002	11x17 / 14x17 mm	100	63
4003	12x20 / 20x20 mm	160	100
4004	12x20 / 20x20 mm	200	130
4005	12x20 / 20x20 mm	250	160

Úhelník nožový - přesný kalený, typ C  
Precision Knife Edge Square "C"  
Kątownik krawędziowy - prec., hartowany, typ C

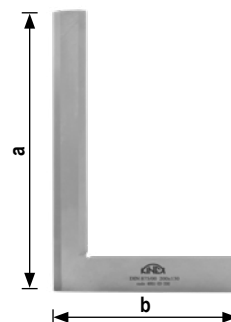

CODE		a [mm]	b [mm]
4001-03-025	6x3,5 / 5x3,5 mm	25	20
4001-03-040	8x3,5 / 5x3,5 mm	40	28
4001-03-063	5,5x16 mm	63	40
4001-03-075	5,5x16 mm	75	50
4001-03-100	5,5x20 mm	100	70
4001-03-150	7,7x25 mm	150	100
4001-03-200	7,7x25 mm	200	130
4001-03-250	7,7x30 mm	250	160
4001-03-300	8x40 mm	300	200

Úhelník svařovaný příložený dilenský - úprava pozink  
Workshop Flat Square  
Kątownik ślusarski ze stopką - wykończenie galwanizowane



CODE	H [mm]	L [mm]	a [mm]	t [mm]
4020-30	100	70	20	5
4020-31	150	100	20	5
4020-32	200	130	20	5
4020-33	250	160	25	5
4020-34	300	180	25	5
4020-35	400	230	30	5
4020-36	500	280	30	5
4020-37	600	330	30	5
4020-38	750	375	30	5
4020-39	1000	500	30	5

Toto provedení úhelníků není určeno ke kalibraci.  
Not intended for calibration.  
Kątownik nie jest przeznaczony do kalibracji.

Úhelník tesařský KINEX BLACK COAT  
Flexible Square KINEX BLACK COAT  
Kątownik stolarski KINEX BLACK COAT



CODE		
4028	30x1 / 32x5 mm	400x230 mm
4029	30x1 / 32x5 mm	750x375 mm
4030	30x1 / 32x5 mm	1000x375 mm

Úhelník tesařský s mm dělením KINEX BLACK COAT  
Flexible Square with mm graduation KINEX BLACK COAT  
Kątownik stolarski ze skalą KINEX BLACK COAT



CODE		
4028-1	30x1 / 32x6 mm	500x230 mm
4029-1	30x1 / 32x6 mm	750x375 mm
4030-1	30x1 / 32x6 mm	1000x375 mm



## Úhelníky | Squares | Kątowniki

Úhelník plochý 45°  
Precision Flat Square 45°  
Kątownik płaski 45°

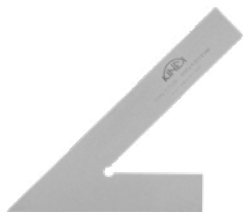

CODE	↔	↔
4006-02-120	20x5 mm	120x 80 mm
4006-02-160	20x5 mm	160x100 mm
4006-02-200	25x5 mm	200x130 mm
4006-02-300	25x5 mm	300x175 mm

Úhelník příložný 45°  
Precision Try Square 45°  
Kątownik ze stopką 45°



CODE	↔	↔
4007-02-120	20x5 mm	120x 80 mm
4007-02-160	20x5 mm	160x100 mm
4007-02-200	25x5 mm	200x130 mm
4007-02-300	25x5 mm	300x175 mm

Vyrábíme a dodáváme úhelníky s různými úhly (60°, 120°, 135°)  
We manufacture and supply squares with different angles (60°, 120°, 135°)  
Produkujemy i dostarczamy kątowniki z różnymi kątami (60°, 120°, 135°)

Trojúhelník  
Triangle  
Trójkąt



CODE	↔	↔
4080	45°	250 mm
4085	60°	250 mm

Úhelník středící  
Centre Square  
Kątownik centrujący

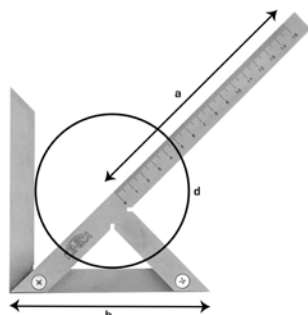

CODE	a [mm]	d [mm]	h [mm]
4062	100	70	90
4062-1	150	130	180
4062-2	200	150	210
4062-3	300	180	250
4062-4	400	250	250
4062-5	500	330	250

Úhelník přírubový, síla 30x5mm  
Flange Square  
Kątownik do ustawiania kołnierzy 30x5mm

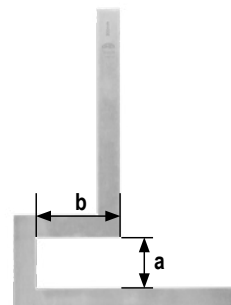

CODE	↔	a [mm]	b [mm]
4063-10	300x300 mm	65	105
4063-11	400x400 mm	65	115
4063-12	500x500 mm	70	125
4063-13	600x600 mm	70	125
4063-14	800x800 mm	95	135

## Vodováhy | Spirit levels | Poziomice

Vodováha digitální  
Digital Spirit Level / Inclinometer  
Poziomica elektroniczna



5017-02-050



5017-02-065



5017-05-150



5017-97-150



CODE		
5017-02-050	0,1°	bez libely   without vial   bez fiolek
5017-02-065	0,01°	s libelou   with vial   fiołką
5017-05-150	0,01°	
5017-97-150	0,01°	s bluetooth   with bluetooth   z bluetooth

Vodováha hadicová  
Hose Level  
Poziomica węzowa (para - szkło)



5035-3



5036

CODE		
5036	pár   pair   para	plast   plastic   plastikowy
5035-3	sada   set   zestaw	10 m
5035-4	sada   set   zestaw	15 m

Vodováha k ustavení sloupků s magnetem - plast  
Hose Level  
Poziomica plastikowa z magnesem



CODE
5036-5

Vodováha digitální zednická  
Digital Level with Laser  
Poziomica elektroniczna



CODE			
5017-02-600	0,1°	2 libely 2 vials 2 fiołki	s laserem (30m) with laser (30m) z laserem (30m)

Vodováha zednická s magnetem  
Spirit Level with Magnets and 3 Vials  
Poziomica z magnesem i 3 ampułkami



CODE		
5018-0	0,5 mm / 1 m	400 mm
5018-1	0,5 mm / 1 m	600 mm
5018-2	0,5 mm / 1 m	800 mm
5018-3	0,5 mm / 1 m	1000 mm
5018-4	0,5 mm / 1 m	1200 mm
5018-5	0,5 mm / 1 m	1500 mm
5018-6	0,5 mm / 1 m	2000 mm

Olovnice  
Plumb  
Poziomica pionowa



5036-02-008



5036-08-006

CODE	
5036-02-008	8 m
5036-08-006	6 m





## Vodováhy | Spirit levels | Poziomice

Vodováha přesná strojní NEW MODEL  
High Precision Spirit Level NEW MODEL  
Poziomica liniarowa NEW MODEL



CODE		
5050-02-150	0,02 mm	150x42x40 mm
5050-02-200	0,02 mm	200x42x40 mm
5050-02-250	0,02 mm	250x42x40 mm
5050-02-300	0,02 mm	300x42x40 mm
5050-02-400	0,02 mm	400x42x40 mm
5050-02-500	0,02 mm	500x42x40 mm

Vodováha přesná strojní s magnetickým upínáním NEW MODEL  
High-precision Longitude Spirit Level, Magnetic clamping NEW MODEL  
Poziomica liniarowa z mocowaniem magnetycznym NEW MODEL

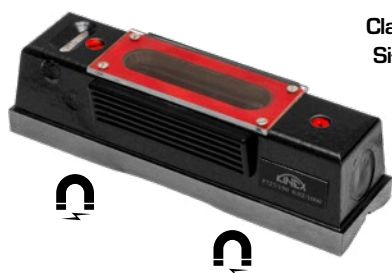

Upínací síla 60 N (6 kg)  
Clamping force 60 N (6 kg)  
Siła zaciskania 60 N (6 kg)

CODE		
5051-02-150	0,02 mm	150x42x40 mm
5051-02-200	0,02 mm	200x42x40 mm
5051-02-250	0,02 mm	250x42x40 mm
5051-02-300	0,02 mm	300x42x40 mm

Vodováha přesná strojní  
Precision Cross Short Level  
Poziomica liniarowa



CODE		
5110-02-100	0,2 mm	100x40x32 mm
5110-02-150	0,2 mm	150x40x32 mm

Vodováha přesná strojní  
Precision Longitude Spirit Level  
Poziomica liniarowa



CODE		
5115-02-150	0,2 mm	150x42x40 mm
5115-02-200	0,2 mm	200x42x40 mm
5115-02-250	0,2 mm	250x42x40 mm
5115-02-300	0,2 mm	300x42x40 mm
5115-02-400	0,2 mm	400x42x40 mm

## Vodováhy | Spirit levels | Poziomice

Vodováha přesná strojní NEW MODEL  
High-precision Spirit Level NEW MODEL  
Poziomnica ramowa NEW MODEL



Vodováha přesná strojní s magn. upínáním  
High-precision Longitude Spirit Level Magnetic  
Poziomnica ramowa z mocowaniem magnetycznym



Upínací síla 60 N (6 kg)  
Clamping force 60 N (6 kg)  
Siła zaciskania 60 N (6 kg)



CODE		
5090-02-150	0,02 mm	150x150x44 mm
5090-02-200	0,02 mm	200x200x44 mm
5090-02-250	0,02 mm	250x250x44 mm
5090-02-300	0,02 mm	300x300x44 mm

CODE		
5091-02-150	0,02 mm	150x150x44 mm
5091-02-200	0,02 mm	200x200x44 mm
5091-02-250	0,02 mm	250x250x44 mm
5091-02-300	0,02 mm	300x300x44 mm

Vodováha přesná strojní NEW MODEL  
High-precision Spirit Level NEW MODEL  
Poziomnica ramowa NEW MODEL



CODE		
5080-02-100	0,2 mm	100x100x25 mm
5080-02-150	0,2 mm	150x150x43 mm
5080-02-200	0,2 mm	200x200x43 mm
5080-02-250	0,2 mm	250x250x43 mm
5080-02-300	0,2 mm	300x300x43 mm



## Vodováhy | Vodováhy | Poziomice centrujące

Kruhová libela - plast  
Circular Vial - plastic  
Poziomica centrująca - plastikowa

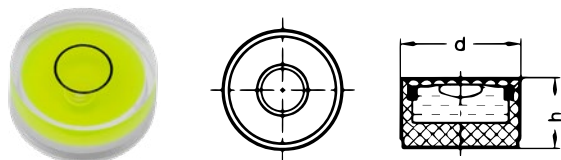

CODE	d [mm]	h [mm]
5022-01-025	25	10,5

Kruhová libela s upevňovacími otvory - plast  
Circular Vial with mounting holes - plastic  
Plastikowa poziomica centrująca z otworami montażowymi

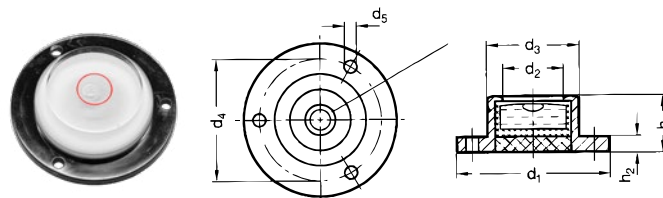

CODE	d1	d2	d3	d4	d5	h1	h2
5022-02-030	40	24	30	36	3,5	11	2,5

Kruhová libela s upevňovacími otvory stříbrná - hliník  
Circular Vial with Mounting Holes - anodized silver  
Aluminiowa poziomica centrująca z otworami montażowymi - srebrna

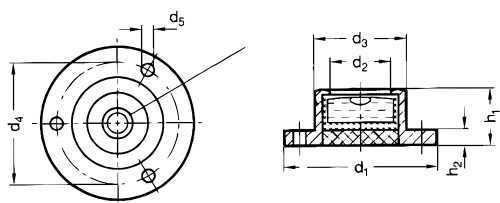

CODE	Angle	d1	d2	d3	d4	d5	h1	h2
5022-03-020	5' - 60' / 2 mm	30	16	20	25	3,5	11	3,5
5022-03-035	5' - 60' / 2 mm	-	28	35	46	3,5	13	3,5
5022-03-060	± 10°	80	57	62	70	5,0	15	5,0
5022-03-075	± 5°	100	60	75	85	5,0	20	8,0

Kruhová libela s upevňovacími otvory černá - hliník  
Circular Vial with Mounting Holes - anodized black  
Aluminiowa poziomica centrująca z otworami montażowymi - czarna

Libela plastová  
Plastic Vial  
Fiolka plastikowa

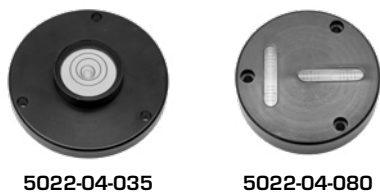
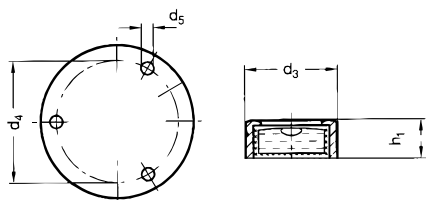

CODE	Angle	d1	d2	d3	d4	d5	h1	h2
5022-04-035	30' / 2 mm (9 mm/m)	80	28	35	70	5,0	18	9
5022-04-080	-	-	-	80	66	5,5	18	-

CODE	Material	Dimensions
5022-1	plast   plastic	40x15x15 mm

## Posuvná měřítka | Calipers | Suwmiarki

Posuvné měřítko s hloubkoměrem a vnitřním měřením, aretace šroubkem

Vernier Caliper with Locking Screw and Depth Gauge

Suwmiarka analogowa z pomiarem głębokości i pomiarem wewnętrznym ze śrubą zabezpieczającą

**DIN**  
862

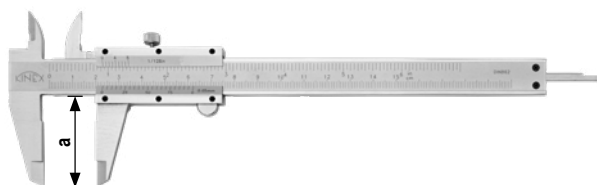

CODE			a [mm]	
6000	0,02 mm	150 mm	40	šroub.   skrutkov.   śruba nonius
6000-1	0,05 mm+inch	150 mm	40	šroub.   skrutkov.   śruba nonius
6000-2	0,02 mm+inch	150 mm	40	monoblok, INOX
6000-25	0,02 mm+inch	160 mm	40	monoblok, INOX
6000-26	0,05 mm+inch	160 mm	40	monoblok, INOX
6000-7	0,02 mm	70 mm	30	monoblok, INOX

Posuvné měřítko s hloubkoměrem a vnitřním měřením, aretace tlačítkem

Vernier Caliper with Thumb Lock and Depth Gauge

Suwmiarka analogowa z pomiarem głębokości i pomiarem wewnętrznym z przyciskiem blokującym

**DIN**  
862

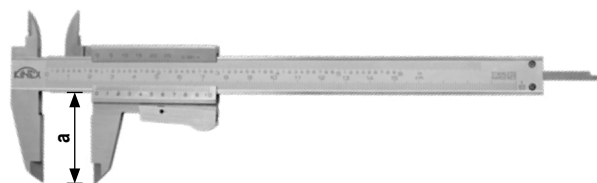

CODE			a [mm]	
6000-3	0,02 mm+inch	150 mm	40	monoblok, INOX
6000-4	0,05 mm+inch	150 mm	40	monoblok, INOX
6000-20	0,02 mm+inch	160 mm	40	monoblok, INOX
6000-21	0,05 mm+inch	160 mm	40	monoblok, INOX

Posuvné měřítko s hloubkoměrem a vnitřním měřením, paralelní vedení, aretace šroubkem, TOP QUALITY

Vernier Caliper with Locking Screw and Depth Gauge, parallax, TOP QUALITY

Suwmiarka analogowa z pomiarem głębokości i pomiarem wewnętrznym, pararelne prowadzenie, śruby aretujące - TOP QUALITY

**DIN**  
862

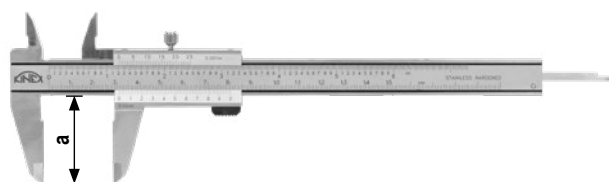

CODE			a [mm]	
6000-02-150	0,02 mm+inch	150 mm	40	monoblok
6000-02-200	0,02 mm+inch	200 mm	50	monoblok
6000-02-300	0,02 mm+inch	300 mm	60	monoblok

Posuvné měřítko PRO LEVÁKY s hloubkoměrem a vnitřním měřením, jemné stavění, paralelní vedení, aretace šroub., TOP QUALITY

Vernier Caliper FOR LEFT-HANDERS with Locking Screw and Depth Gauge, paralex line type, TOP QUALITY

Suwmiarka DLA LEWORĘCZNYCH analogowa z pomiarem głębokości i pomiarem wewnętrznym, pararelne prowadzenie, śruby aret. - TOP QUALITY

**DIN**  
862

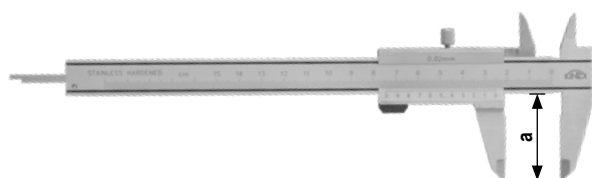

CODE			a [mm]	
6000-12-150	0,02 mm	150 mm	40	monoblok



## Posuvná měřítka | Calipers | Suwmiarki

Posuvné měřítko s vnitřním měřením, jemné stavění  
Vernier Caliper with Locking Screw and Depth Gauge, Fine Adjustment  
Suwmiarka ze šrubą i suwakiem pomocniczym

ČSN  
25 1238

DIN  
862

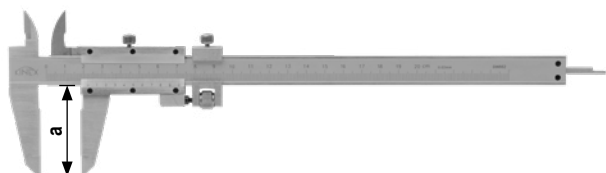

CODE			a [mm]	
6002	0,02 mm	200 mm	50	šroub.   screw   śruba non.
6003	0,02 mm	300 mm	55	šroub.   screw   śruba non.

Posuvné měřítko s vnitřním měřením a hloubkoměrem, jemné stavění  
Vernier Caliper with Locking Screw and Depth Gauge, Fine Adjustment  
Suwmiarka ze šrubą i suwakiem pomocniczym, precyzyjna regulacja

DIN  
862

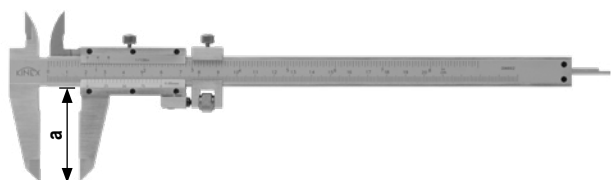

CODE			a [mm]	
6002-90-1	0,05 mm + 1/128 inch	200 mm	50	šroub.   screw   śruba non.
6003-90-1	0,05 mm + 1/128 inch	300 mm	55	šroub.   screw   śruba non.

Posuvné měřítko s číselníkovým úchylkoměrem ANTISHOCK (nárazuvzdorné provedení)  
Dial Caliper and Depth Gauge ANTISHOCK  
Suwmiarka z czujnikiem zegarowym ANTISHOCK (wstrząsoodporny projekt)

ČSN  
25 1235

DIN  
862



CODE			a [mm]
6013-02-150	0,02 mm	150 mm	40
6013-02-200	0,02 mm	200 mm	45
6013-02-300	0,02 mm	300 mm	55

Posuvné měřítko mosazné (nemagnetické)  
Vernier Brass Caliper  
Zacisk mosiężny (niemagnetyczny)

0,1



Hloubkoměr mosazný (nemagnetický)  
Depth Brass Caliper  
Miernik głębokości mosiądzu (niemagnetyczny)

0,1



CODE	
6029-02-100	0 -100 mm



CODE	
2029-02-030	0 -30 mm

## Posuvná měřítka na rýsování | Marking Calipers | Suwmiarki do rysowania

Posuvné měřítka na rýsování - hrot slinutý karbid  
 Marking Caliper - Cemented Carbide Tip  
 Suwmiarka traserska z rysikiem, grot węglkowy

0,02

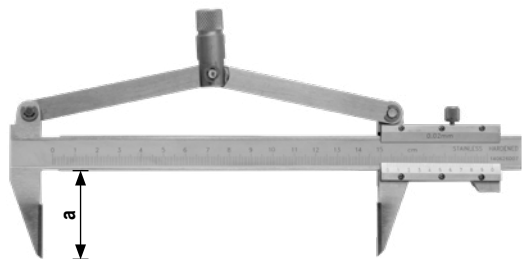

CODE		a [mm]
6005-10	150 mm	40
6005-15	200 mm	40
6005-20	250 mm	40
6005-25	300 mm	40

Posuvné měřítka rýsovací s výměnným hrotem, šroubovací nonius  
 Marking Caliper with Replaceable Tip & Screw Vernier  
 Suwmiarka traserska z rysikiem, grotom węglkowym, śrubą noniusza

0,1



CODE	hrot   tip   końcówka	
6005-50	29x2 mm	200/40 mm
6005-55	29x2 mm	400/40 mm
6006-2	náhr. hrot - tvrdokov   repl. tip - carbide   zapasowa końcówka utwardzana	

Přípravek na orýsování s mm stupnicí NEREZOVÁ OCEL  
 Steel Marking Gauge STAINLESS STEEL  
 Przyrząd kreskowy nastawny STAL NIERDZEWNA

INOX

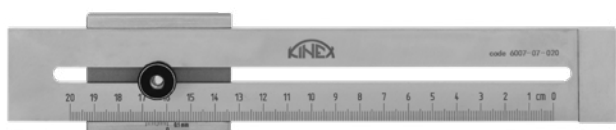

CODE	
6007-07-015	150 mm
6007-07-020	200 mm
6007-07-030	300 mm

Posuvné měřítka na rýsování paralelní typ T  
 Steel Marking Gauge type T  
 Suwmiarka traserska równoległa typu T

0,05

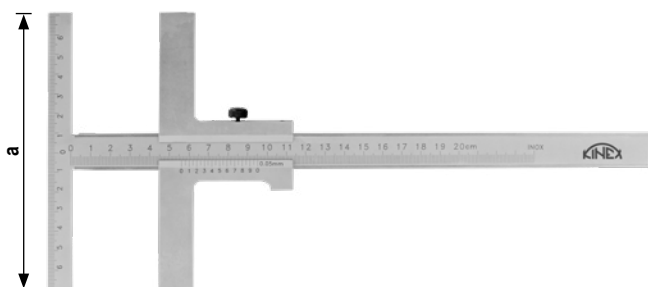

CODE		a [mm]
6007-02-160	160 mm	120
6007-02-200	200 mm	140
6007-02-250	250 mm	140
6007-02-300	300 mm	160
6007-02-400	400 mm	160
6007-02-500	500 mm	160



## Posuvná měřítka | Calipers | Suwmiarki

Posuvné měřítka s jemným stavěním, šroubovací nonius  
 Vernier Caliper with Locking Screw and Fine Adjustment, vernier screw  
 Suwmiarka jednostronna z suwakiem pomocniczym, śruba noniusza

NEW  
LINE

ČSN  
EN ISO  
13385-1

ČSN  
25 1231

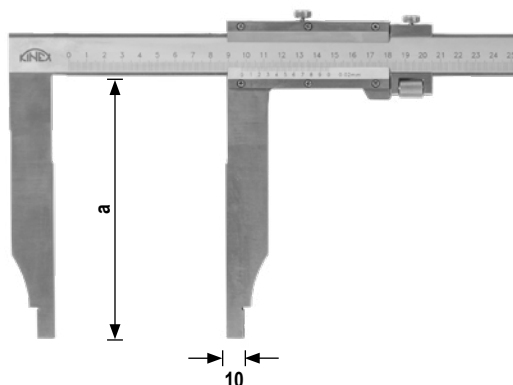

Od 500 mm dodáváno včetně protokolu o přeměření.  
 From 500 mm supplied with the Measuring Protocol.  
 Od 500 mm dostarczamy wraz z protokołem o przemierzeniu.

CODE			a [mm]
6015-62-100	0,02 mm	400 mm	100
6015-02-100	0,02 mm	500 mm	100
6015-02-125	0,02 mm	500 mm	125
6015-02-150	0,02 mm	500 mm	150
6015-02-200	0,02 mm	500 mm	200
6015-12-100	0,02 mm	600 mm	100
6015-12-125	0,02 mm	600 mm	125
6015-12-150	0,02 mm	600 mm	150
6015-12-200	0,02 mm	600 mm	200
6015-22-150	0,02 mm	800 mm	150
6015-22-200	0,02 mm	800 mm	200
6015-32-125	0,02 mm	1000 mm	125
6015-32-150	0,02 mm	1000 mm	150
6015-32-200	0,02 mm	1000 mm	200
6015-42-150	0,02 mm	1500 mm	150
6015-42-200	0,02 mm	1500 mm	200
6015-52-200	0,05 mm	2000 mm	200
6015-52-300	0,05 mm	2000 mm	300
6015-72-200	0,05 mm	2500 mm	200
6015-72-300	0,05 mm	2500 mm	300

Posuvné měřítka s jemným stavěním a stupnicí mm + inch  
 Vernier Caliper with Locking Screw and Fine Adjustment, mm + inch  
 Suwmiarka jednostronna z suwakiem pomocniczym i skalą mm + inch

ČSN  
EN ISO  
13385-1

ČSN  
25 1231

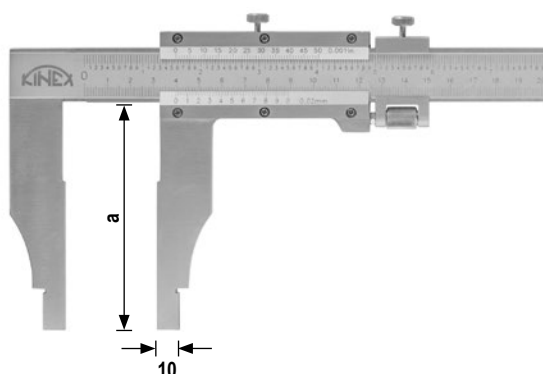

CODE			a [mm]
6015-08-040	0,05 mm + 1/128inch	400 mm	100
6015-08-050	0,05 mm + 1/128inch	500 mm	125
6015-08-060	0,05 mm + 1/128inch	600 mm	125
6015-08-100	0,05 mm + 1/128inch	1000 mm	125
6015-08-150	0,05 mm + 1/128inch	1500 mm	125

## Posuvná měřítka | Calipers | Suwmiarki

Posuvné měřítko oboustranné s jemným stavěním, šroubovací nonius  
 Vernier Caliper with Locking Screw and Fine Adjustment  
 Suwmiarka z suwakiem pomocniczym, śruba noniusza

ČSN  
 EN ISO  
 13385-1

ČSN  
 25 1234

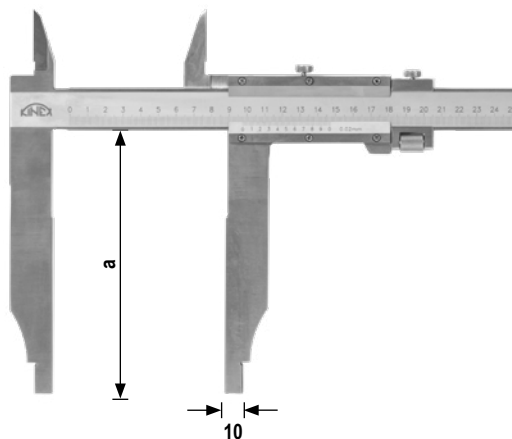

CODE			a [mm]
6022-62-100	0,02 mm	400 mm	150
6022-02-150	0,02 mm	500 mm	150
6022-12-150	0,02 mm	600 mm	150
6022-22-150	0,02 mm	800 mm	150
6022-32-150	0,02 mm	1000 mm	150
6022-42-200	0,02 mm	1500 mm	200
6022-52-150	0,02 mm	2000 mm	150
6022-52-200	0,05 mm	2000 mm	200

Od 500 mm dodáváno včetně protokolu o přeměření.  
 From 500 mm supplied with the Measuring Protocol.  
 Od 500 mm dostarczamy wraz z protokołem o przemierzeniu.





## Posuvná měřítka | Calipers | Suwmiarki

Digitální posuvné měřítka KINEX Labo ICONIC do vlhkého prostředí  
 Digital Caliper KINEX ICONIC Labo - moisture resistant IP 67, TOP QUALITY, PC  
 Suwmiarka elektroniczna KINEX Labo ICONIC do środowiska wilgotnego



Dodáváno včetně protokolu o přeměření,  
 Supplied with the Measuring Protocol.  
 Dostarczamy wraz z protokołem o przemierzaniu.

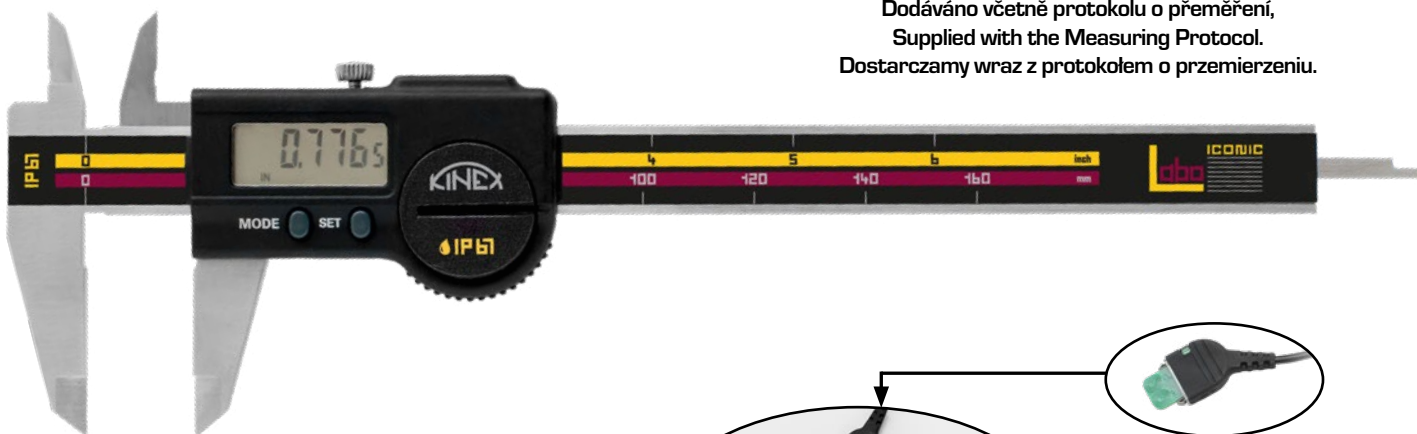

- » Ochrana **IP67** i při připojení datového kabelu **KINEX ICL**
- » Systém **IIS** – Inteligentní Induktivní Snímač s korekcí chyb
- » Automatické zapnutí **pohybem** DIGI jednotky
- » Automatické vypnutí po **20 minutách** nečinnosti
- » Paměť poslední měřené hodnoty
- » Maximální rychlost pohybu **2,5m/s**
- » **Nerezové** broušené tělo odolné proti agresivnímu solnému prostředí

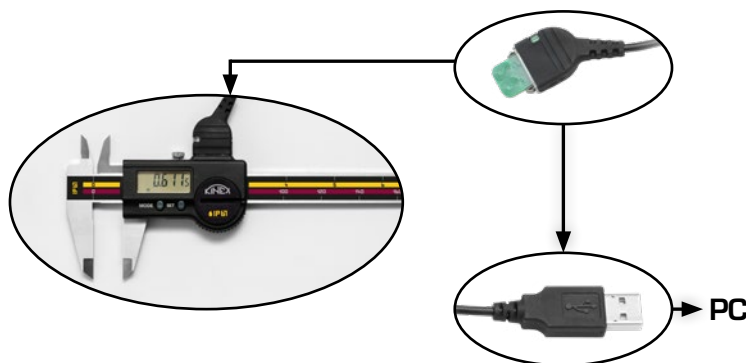

- » **Water protected IP67** for work with coolants and lubricants, **even connected**
- » **Automatic wake-up** by moving the electronic on his frame. (system IIS)
- » Position memorized in sleeping mode (system IIS), absolute system
- » **Sleeping mode** after 20 minutes of no use. (system IIS)
- » Maximum speed of displacement : 2.5 m/sec

- » Stopień ochrony **IP67** nawet po podłączeniu kabla do transmisji danych **KINEX ICL**
- » System **IIS** – Inteligentny czujnik indukcyjny korekcji błędów
- » Automatyczne włączenie **poprzez poruszenie jednostki**
- » Automatycznie odłączenie po **20 minutach** bezczynności
- » Pamięć ostatnich wartości mierzonych
- » Maksymalna prędkość **2,5m/s**
- » Ciało polerowana **stal nierdzewna** odporna na agresywne środowisko soli

CODE	L	a	b	c	d	
6040-27-150	0 - 150 mm	234,5	40,0	11,0	26,0	16x3,5
6040-27-200	0 - 200 mm	290,5	50,0	14,0	26,0	16x3,5
6040-27-300	0 - 300 mm	388,0	64,0	14,0	26,0	16x4,0

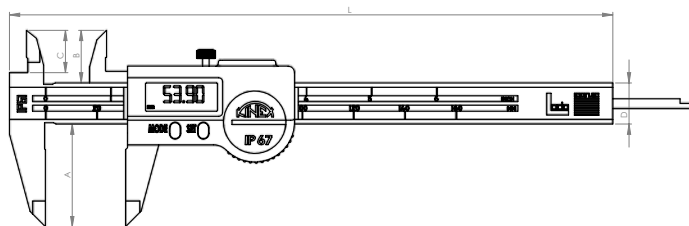

Interface pro připojení k PC na posuvná měřítka a digitální mikrometry KINEX Labo ICONIC  
 PC Interface for KINEX ICONIC Labo  
 Interface do połączenia z komputerem KINEX Labo ICONIC



**CODE**  
6040-27-900

## Posuvná měřítka | Calipers | Suwmiarki

Digitální posuvné měřítko KINEX ABSOLUTE ZERO  
 Digital Caliper KINEX ABSOLUTE ZERO  
 Suwmiarka elektroniczna KINEX ABSOLUTE ZERO



0,01



automatické vypínání při nečinnosti  
 automatic sleep when idle  
 automatycznie wyłączenie w stanie bezczynności

Dodáváno včetně protokolu o přeměření.  
 Supplied with the Measuring Protocol.  
 Dostarczamy wraz z protokołem o przemierzeniu.

CODE		L [mm]	a [mm]	b [mm]	c [mm]	d [mm]
6040-05-100	0 - 100 mm	184,5	40	11	16	16x3,5
6040-05-150	0 - 150 mm	234,5	40	11	16	16x3,5
6040-05-151*	0 - 150 mm	234,5	40	11	16	16x3,5
6040-05-200	0 - 200 mm	290,5	50	14	19	16x3,5
6040-05-300	0 - 300 mm	388,0	64	14	19	16x4,0

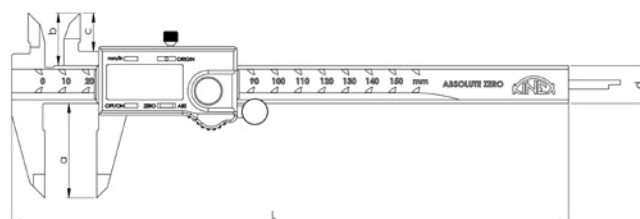

\* kulatý hloubkoměr | round depth | okrągłe głębia ø1,5

Interface pro připojení k PC na posuvná měřítka a digitální mikrometry KINEX ABSOLUTE ZERO  
 PC Interface for KINEX ABSOLUTE ZERO  
 Interface do połączenia z komputerem KINEX ABSOLUTE ZERO



CODE	
6040-05-900	interface
6040-05-901	nožní spínač   footswitch   przełącznik nożny
6040-05-902	kabel

Digitální posuvné měřítko KINEX ABZ DESIGN  
 Digital Caliper KINEX ABZ DESIGN  
 Suwmiarka elektroniczna KINEX ABZ DESIGN



0,01



automatické vypínání při nečinnosti  
 automatic sleep when idle  
 automatycznie wyłączenie w stanie bezczynności

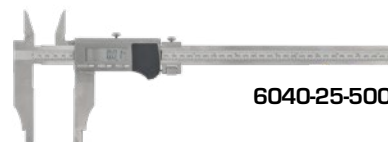

6040-25-500

Dodáváno včetně protokolu o přeměření.  
 Supplied with the Measuring Protocol.  
 Dostarczamy wraz z protokołem o przemierzeniu.

CODE		a [mm]	b [mm]	c [mm]	d [mm]
6040-25-150	0,01 mm 0 - 150 mm	40	22,5	16,8	16 IP67
6040-25-200	0,01 mm 0 - 200 mm	50	25,5	19,8	16 IP67
6040-25-300	0,01 mm 0 - 300 mm	60	27	21	17 IP67
6040-25-500	0,01 mm 0 - 500 mm	100	45	39	24 IP66

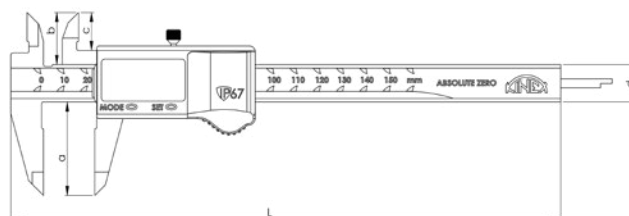



## Posuvná měřítka | Calipers | Suwmiarki

Posuvné měřítko digitální - tvrdokov  
Digital Caliper - carbide  
Suwmiarka elektroniczna - węgiel



0,01

DIN  
862



tvrdokov | carbide | węgiel

CODE			a [mm]
6041-25-150	0,01 mm	0 - 150 mm	40 mm

automatické vypínání při nečinnosti  
automatic sleep when idle  
automatycznie wyłączenie w stanie bezczynności

Posuvné měřítko digitální  
Digital Caliper  
Suwmiarka elektroniczna

0,01

DIN  
862



CODE			a [mm]
6040-2	0,01 mm	0 - 150 mm	40 mm
6041-2	0,01 mm	0 - 200 mm	50 mm
6042-2	0,01 mm	0 - 300 mm	60 mm

Posuvné měřítko digitální  
Digital Caliper  
Suwmiarka elektroniczna

0,01

DIN  
862



CODE			a [mm]
6040-02-150	0,01 mm	0 - 150 mm	40 mm
6040-02-200	0,01 mm	0 - 200 mm	50 mm
6040-02-300	0,01 mm	0 - 300 mm	60 mm

Posuvné měřítko digitální - pro leváky  
Digital Caliper for left-handers  
Suwmiarka elektroniczna - dla leworęcznych

0,01

DIN  
862



CODE			a [mm]
6040-14-150	0,01 mm	150 mm	40
6040-14-200	0,01 mm	200 mm	50
6040-14-300	0,01 mm	300 mm	60

## Posuvná měřítka | Calipers | Suwmiarki

Posuvné měřítka digitální solární  
Digital Solar Caliper  
Suwmiarka elektroniczna, fotowoltaiczna

0,01

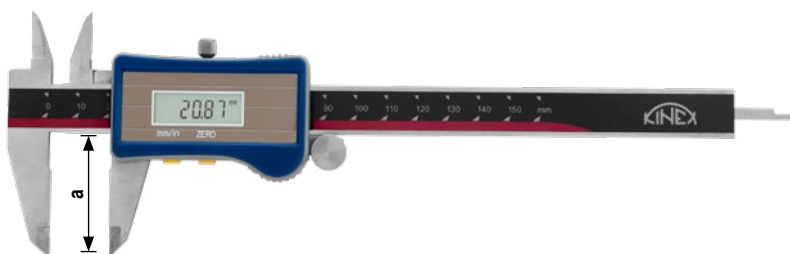

CODE			a [mm]
6040-15-150	0,01 mm	150 mm	40
6040-15-200	0,01 mm	200 mm	40
6040-15-300	0,01 mm	300 mm	40

Posuvné měřítka digitální - bez horních nožů  
Digital Caliper - without upper jaws  
Suwmiarka elektroniczna - bez górnych noży

0,01

**DIN**  
862



CODE			a [mm]
6042-20	0,01 mm	300	90 mm

Posuvné měřítka digitální nožové  
Digital Blade Caliper  
Suwmiarka elektroniczna specjalna

0,01

**DIN**  
862



CODE			a [mm]	b [mm]
6040-75-200	0,01 mm	200 mm	70	17
6040-75-210	0,01 mm	200 mm	100	20

Nástavec pro digitální posuvná měřítka do 300mm  
Extension for Digital Calipers up to 300mm  
Przedłużacz elektronicznych suwmiarek do 300 mm

**NEW**

CODE

6040-00-075





## Posuvná měřítka | Calipers | Suwmiarki

Posuvné měřítko digit. - bez horních nožů  
 Digital Caliper with Locking Screw & Fine Adjustment  
 Suwmiarka elektr. - bez górnych nožů

0,01

DIN  
862

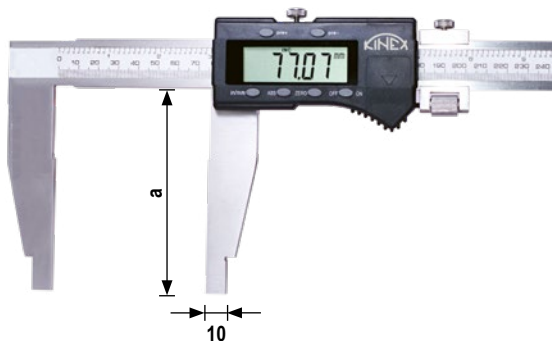

Posuvné měřítko digit. - s horními noži  
 Digital Caliper with Locking Screw & Fine Adjustment  
 Suwmiarka elektr. - z górnyimi nožami

0,01

DIN  
862

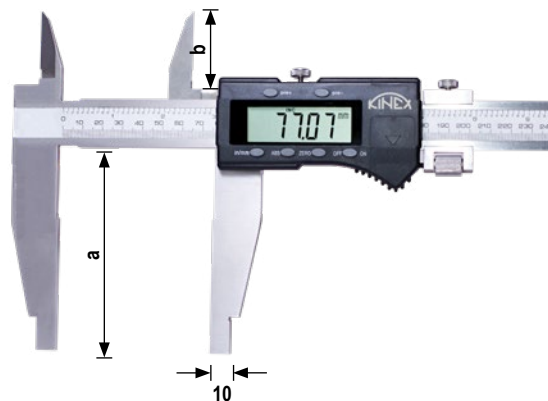

CODE			a [mm]
6043-65-100	0,01 mm	400 mm	100
6043-05-100	0,01 mm	500 mm	100
6043-05-125	0,01 mm	500 mm	125
6043-05-150	0,01 mm	500 mm	150
6043-05-200	0,01 mm	500 mm	200
6043-15-100	0,01 mm	600 mm	100
6043-15-125	0,01 mm	600 mm	125
6043-15-150	0,01 mm	600 mm	150
6043-15-200	0,01 mm	600 mm	200
6043-15-300	0,01 mm	600 mm	300
6043-25-125	0,01 mm	800 mm	125
6043-25-150	0,01 mm	800 mm	150
6043-35-125	0,01 mm	1000 mm	125
6043-35-150	0,01 mm	1000 mm	150
6043-45-150	0,01 mm	1500 mm	150
6043-45-200	0,01 mm	1500 mm	200
6043-45-300	0,01 mm	1500 mm	300
6043-55-150		2000 mm	150
6043-75-200		2500 mm	200
6043-75-300		2500 mm	300

CODE			a [mm]	b [mm]
6044-65-150	0,01 mm	400 mm	150	38
6044-05-100	0,01 mm	500 mm	100	38
6044-05-125	0,01 mm	500 mm	125	51,5
6044-05-150	0,01 mm	500 mm	150	51,5
6044-05-200	0,01 mm	500 mm	200	51,5
6044-15-100	0,01 mm	600 mm	100	38
6044-15-125	0,01 mm	600 mm	125	51,5
6044-15-150	0,01 mm	600 mm	150	51,5
6044-15-200	0,01 mm	600 mm	200	51,5
6044-25-125	0,01 mm	800 mm	125	51,5
6044-25-150	0,01 mm	800 mm	150	51,5
6044-35-125	0,01 mm	1000 mm	125	51,5
6044-35-150	0,01 mm	1000 mm	150	51,5
6044-45-150	0,01 mm	1500 mm	150	61
6044-55-150		2000 mm	150	61
6044-55-200		2000 mm	200	61

Od 500mm dodáváno včetně protokolu o přeměření  
 From 500 mm supplied with the Measuring Protocol  
 Od 500 mm dostarczamy wraz z protokołem o przemierzeniu.

## Posuvná měřítka | Calipers | Suwmiarki

Posuvné měřítka digitální na zápichy vnitřní ABZ DESIGN  
 Digital Groove Inside Caliper - ABZ DESIGN  
 Suwmiarka elektroniczna do kanałków wewnętrznych ABZ DESIGN

0,01

DIN  
862

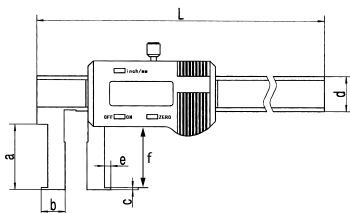

CODE	L [mm]	a [mm]	b [mm]	c [mm]	d [mm]	e [mm]	f [mm]
6040-55-150	22 - 150 mm	250	30	11	1,0	16	5
6040-55-200	25 - 200 mm	310	40	12	1,0	16	5
6040-55-300	30 - 300 mm	410	50	15	1,5	17	5

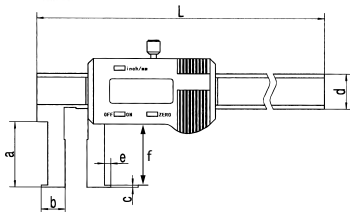

do malých otvorů | do malých otvorov | w małych otworów



CODE	L [mm]	a [mm]	b [mm]	c [mm]	d [mm]	e [mm]	f [mm]
6040-55-151	14 - 150 mm	236	30	12	1,0	16	5

Posuvné měřítka digitální na zápichy vnější ABZ DESIGN  
 Digital Groove Outside Caliper - ABZ DESIGN  
 Suwmiarka elektroniczna do kanałków zewnętrznych ABZ DESIGN

0,01

DIN  
862

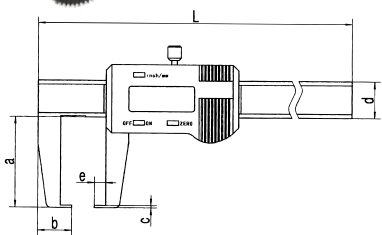
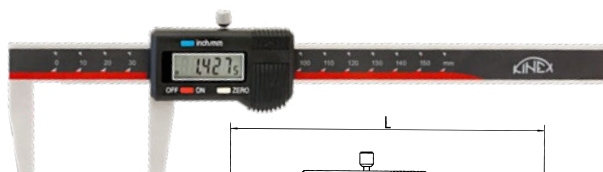

CODE	L [mm]	a [mm]	b [mm]	c [mm]	d [mm]	e [mm]
6040-65-150	0 - 150 mm	250,0	40,0	15,0	1,0	16,0
6040-65-200	0 - 200 mm	310,0	50,0	19,0	1,0	16,0
6040-65-300	0 - 300 mm	400,0	60,0	21,0	1,5	17,0

Posuvné měřítka digitální na brzdové bubny  
 Digital Disc Brake Caliper  
 Suwmiarka elektroniczna do tarcz hamulcowych



0,01

Posuvné měřítka digitální na ozubená kola  
 Digital Gear Tooth Caliper  
 Suwmiarka elektroniczna do kół zębatych



0,01



CODE	L [mm]
6041-15-025	M1 - 25
6041-15-050	M5 - 50



6041-35-060

CODE	L [mm]
6041-35-060	0 - 60 mm
6041-35-100	0 - 100 mm



6041-35-100



## Posuvná měřítka | Calipers | Suwmiarki

Posuvné měřítka digitální na měření síly trubek  
Digital Caliper for Tube Thickness  
Suwmiarka elektroniczna do pomiaru grubości rurek

0,01

DIN  
862

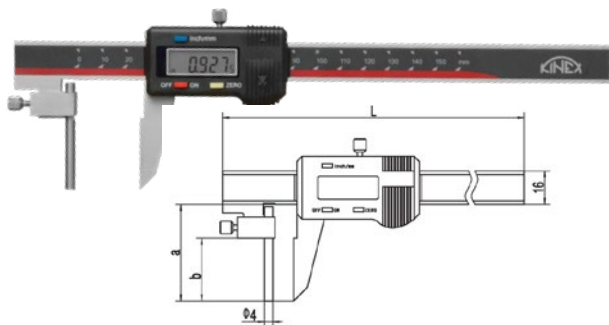

CODE		L [mm]	a [mm]	b [mm]
6040-85-150	0 - 150 mm	250	46	30
6040-85-200	0 - 200 mm	300	56	40
6040-85-300	0 - 300 mm	400	66	50

Posuvné měřítka rýsovací s výměnným hrotem  
Marking Caliper with Replaceable Tip  
Suwmiarka traserska z rysikiem, grotem węglkowym

NEW

0,01

Přípravek na orýsování - digitální  
Digital Marking Gauge  
Przyrząd kreskowy nastawny elektroniczny

NEW

0,01



CODE	
6041-55-150	0 - 150 mm



CODE	
6041-45-200	0 - 200 mm

Posuvné měřítka na měření průměru lan  
Digital Rope Caliper  
Przyrząd kreskowy nastawny elektroniczny

NEW

0,01



CODE	
6041-75-200	0 - 200 mm

Digitální posuv ABZ DESIGN  
Digital Scale Unit - ABZ DESIGN  
Liniał elektroniczny ABZ DESIGN

DIN  
862



### VERTIKÁLNÍ | VERTICAL | PIONOWY

CODE		L [mm]
6040-45-150	0,01 mm	150 mm
6040-45-200	0,01 mm	200 mm
6040-45-300	0,01 mm	300 mm
6040-45-400	0,01 mm	400 mm
6040-45-500	0,01 mm	500 mm
6040-45-600	0,01 mm	600 mm



### HORIZONTÁLNÍ | HORIZONTAL | POZIOMY

CODE		L [mm]
6040-35-150	0,01 mm	150 mm
6040-35-200	0,01 mm	200 mm
6040-35-300	0,01 mm	300 mm
6040-35-400	0,01 mm	400 mm
6040-35-500	0,01 mm	500 mm
6040-35-600	0,01 mm	600 mm

## Posuvná měřítka | Calipers | Suwmiarki

Náhradní baterie  
Spare battery  
Bateria zapasowa



### CODE

6040-1	LR44 1,55V
6040-01	CR2032 3V
6040-05	CR1632 3V, Lithium

Posuvné plastové měřítka - HOBBY  
Digital Caliper Plastic - HOBBY  
Suwmiarka analogowa z tworzywa sztucznego - HOBBY

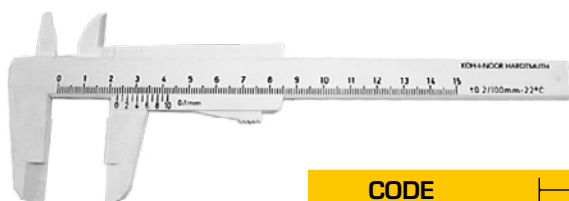

### CODE

6050 150/40 mm

Digitální posuvné měřítka plastové  
Digital Caliper Plastic  
Suwmiarka elektroniczna z tworzywa sztucznego



### CODE

6050-02-150 150/40 mm

## Lesnické průměrky | Forester Calipers | Suwmiarki leśnicze

Lesnická průměrka s permanentní brzdou a stupnicí s laserovým popisem, Red&Black LINE  
Forester Caliper Red&Black LINE  
Suwmiarka leśnicza z blokadą z opisem laserowym, Red&Black LINE

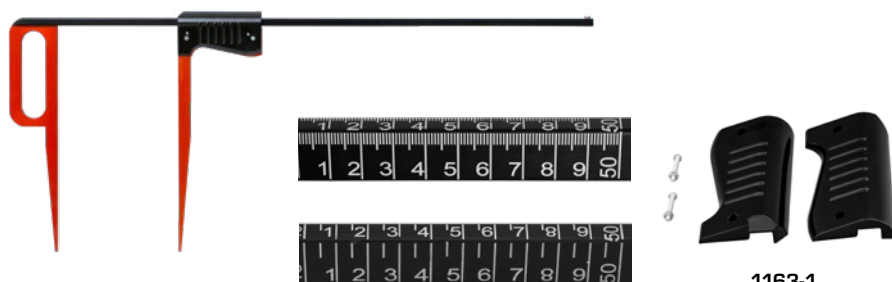

### CODE

CODE	Scale	Length
1162-08-050	1 mm	500/255 mm
1162-08-080	1 mm	800/410 mm
1162-08-100	1 mm	1000/410 mm
1162-05-050	5 mm	500/255 mm
1162-05-080	5 mm	800/410 mm
1162-05-100	5 mm	1000/410 mm
1163-1	náhradní madlo spare handle uchwyt wymienny	pár pair para





## Mikrometry | Micrometres | Mikrometry

Mikrometr třmenový  
Outside Micrometer  
Mikrometr zewnętrzny

0,01

ČSN  
25 1420

DIN  
863

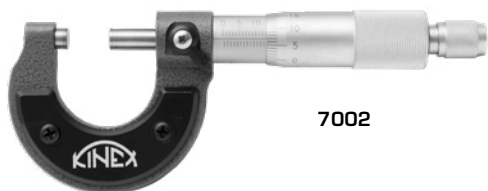

7002



7004 - 7008

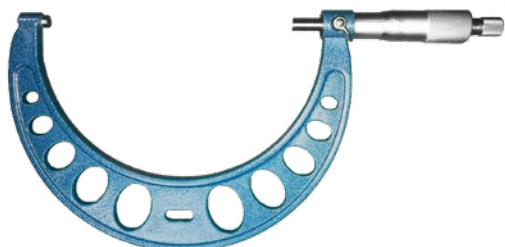

7011 - 7025



7025-0  
7026-0

NEW  
LINE

CODE		L
7002	0,01 mm	0 - 25 mm
7004	0,01 mm	25 - 50 mm
7006	0,01 mm	50 - 75 mm
7008	0,01 mm	75 - 100 mm
7011	0,01 mm	100 - 125 mm
7013	0,01 mm	125 - 150 mm
7015	0,01 mm	150 - 175 mm
7017	0,01 mm	175 - 200 mm
7019	0,01 mm	200 - 225 mm
7021	0,01 mm	225 - 250 mm
7023	0,01 mm	250 - 275 mm
7025	0,01 mm	275 - 300 mm
7025-0	0,01 mm	100 - 200 mm
7026-0	0,01 mm	200 - 300 mm
7026	0,01 mm	300 - 400 mm
7027	0,01 mm	400 - 500 mm
7027-1	0,01 mm	500 - 600 mm
7027-2	0,01 mm	600 - 700 mm
7027-3	0,01 mm	700 - 800 mm
7027-4	0,01 mm	800 - 900 mm
7027-5	0,01 mm	900 - 1000 mm

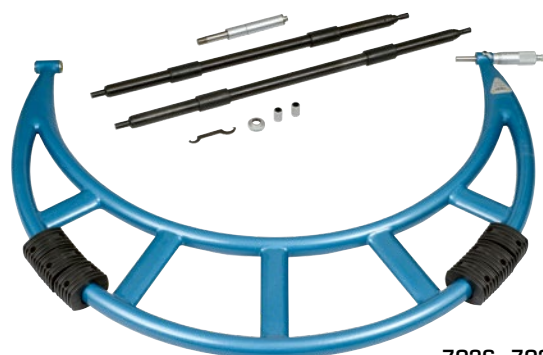

7026 - 7027-5

Dodáváno včetně nastavovacího kalibru.  
Supplied with Setting Gauge.  
Dostarczamy wraz z krążkiem ustawiającym.

## Mikrometry | Micrometres | Mikrometry

Mikrometr třmenový - PROFESSIONAL  
 Outside Micrometer - PROFESSIONAL  
 Mikrometr zewnętrzny - PROFESSIONAL

**DIN**  
863

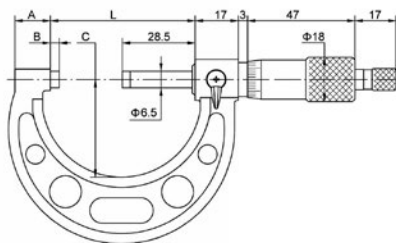

CODE		
7002-02-025	0,01 mm	0 - 25 mm

Nastavovací kalibr mikrometru  
 Setting Gauge for Micrometers  
 Wzorec nastawczy do mikrometru

**DIN**  
863



CODE	
7002-00-025	25 mm
7002-00-050	50 mm
7002-00-075	75 mm
7002-00-100	100 mm

Mikrometr třmenový na závit  
 Screw Thread Micrometer  
 Mikrometr do gwintu

**DIN**  
863



CODE		
7028-31	0,01 mm	0 - 25 mm
7028-32	0,01 mm	25 - 50 mm
7028-33	0,01 mm	50 - 75 mm
7028-34	0,01 mm	75 - 100 mm
7028-35	0,01 mm	100 - 125 mm
7028-36	0,01 mm	125 - 150 mm
7028-37	0,01 mm	150 - 175 mm
7028-38	0,01 mm	175 - 200 mm

Nástavce na závit - pár  
 V-shaped and Knife Anvils - pair  
 Końcówki mikrometru do pomiaru gwintu - para



CODE		stoupání   stúpanie   rosnać
7028-41	60°	0,40 - 0,50 mm
7028-42	60°	0,60 - 0,90 mm
7028-43	60°	1,00 - 1,75 mm
7028-44	60°	2,00 - 3,00 mm
7028-45	60°	3,50 - 5,00 mm
7028-46	60°	5,50 - 7,00 mm



## Mikrometry | Micrometres | Mikrometry

Mikrometr KINEX Labo ICONIC - třmenový, digitální  
 Digital Outside Micrometer KINEX ICONIC Labo  
 Mikrometr KINEX Labo ICONIC - zewnętrzny, elektroniczny

NEW LINE

10mm

INOX

0,001



IP 67

DIN 863



Dodáváno včetně protokolu o přeměření  
 Supplied with the Measuring Protocol  
 Dostarczamy wraz z protokołem o przemierzeniu



### BLUETOOTH SIMPLE PROFILE

Integrovaný bezdrátový přenos dat přes Bluetooth pro základní použití se k připojení jako zařízení standardu HID, není potřeba žádný další software

Integrated wireless data transfer via Bluetooth for basic use, connect as HID standard device, no additional software is needed.

Zintegrowany bezprzewodowy transfer danych poprzez Bluetooth. Do codziennego użytkowania. Podłącz jako urządzenie standardowe HID, żadne dodatkowe oprogramowanie nie jest potrzebne.

- » Ochrana **IP67**
- » Systém **IIS** – Inteligentní Induktivní Snímač s korekcí chyb
- » Automatické zapnutí **pohybem** DIGI jednotky
- » Automatické vypnutí po **20 minutách** nečinnosti
- » Paměť poslední měřené hodnoty
- » Maximální rychlost pohybu **2,5m/s**
- » **Nerezové** broušené tělo odolné proti agresivnímu solnému prostředí
- » **Water protected** for heavy-duty work with coolants and lubricants, protection rating **IP67** according to IEC 60529
- » **Automatic wake-up** by moving the measuring spindle (system S.I.S)
- » Sleeping mode after 20 min. of no use (system S.I.S)
- » **Position memorized in sleeping mode** (system S.I.S), absolute system
- » Quick displacement of the measuring spindle **12 mm / rotation**
- » **Adjustable measuring force** 5N / 10N (version 7030-27-030)
- » Repeatability and reproducibility never reached before
- » Measuring range **0-102 mm covered with 3 instruments only**
- » Stopień ochrony **IP67**
- » System **IIS** – Inteligentny czujnik indukcyjny korekcji błędów
- » Automatyczne włączenie **poprzez poruszenie jednostki**
- » Automatycznie odłączenie po **20 minutach** bezczynności
- » Pamięć ostatnich wartości mierzonych
- » Maksymalna prędkość **2,5m/s**
- » Ciało polerowana **stal nierdzewna** odporna na agresywne środowisko sol

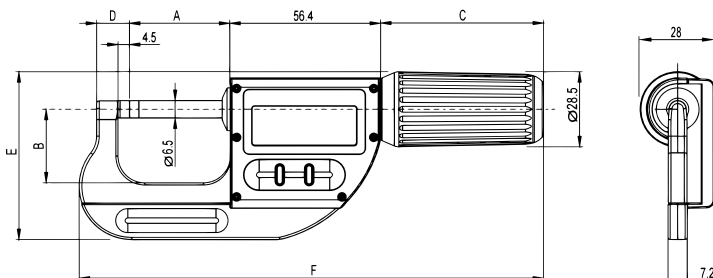

CODE		A [mm]	B [mm]	C [mm]	D [mm]	E [mm]	F [mm]	G [mm]
7031-97-030	0 - 30 mm	37,3	27,5	62,0	12,5	63,0	174	7,2
7031-97-066	30 - 66 mm	73,3	43,0	74,0	13,5	86,0	230	9,0
7031-97-102	66 - 102 mm	109,3	60,0	74,0	14,5	106,0	269	9,0

## Mikrometry | Micrometres | Mikrometry

Mikrometr KINEX ABSOLUTE ZERO - třmenový, digitální  
 Digital Outside Micrometer KINEX ABSOLUTE ZERO  
 Mikrometr KINEX ABSOLUTE ZERO - zewnętrzny, elektroniczny

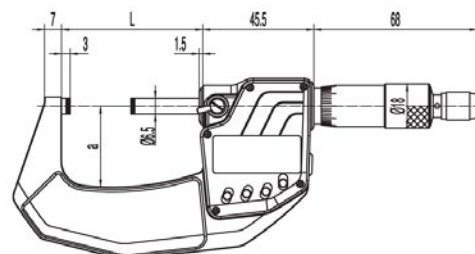

Dodáváno včetně nastavovacího kalibru a protokolu o přeměření.  
 Supplied with Setting Gauge and Protocol of remeasurement.  
 Dostarczamy wraz z krążkiem ustawiającym i protokołem o przemierzeniu.

CODE		L [mm]	a [mm]
7030-05-025	0 - 25 mm	33,0	25,0
7030-05-050	25 - 50 mm	58,0	32,5
7030-05-075	50 - 75 mm	83,0	47,5
7030-05-100	75 - 100 mm	108,0	60,0

Interface pro připojení k PC na posuvná měřítka a digitální mikrometry KINEX ABSOLUTE ZERO  
 PC Interface for Digital Calipers, Micrometers, Indicators KINEX ABSOLUTE ZERO  
 Interface do połączenia z komputerem KINEX ABSOLUTE ZERO



CODE	
6040-05-9001	interface
6040-05-901	nožní spínač   footswitch   przełącznik nożny
6040-05-903	kabel

Mikrometr třmenový digitální  
 Digital Outside Micrometer  
 Mikrometr zewnętrzny elektroniczny

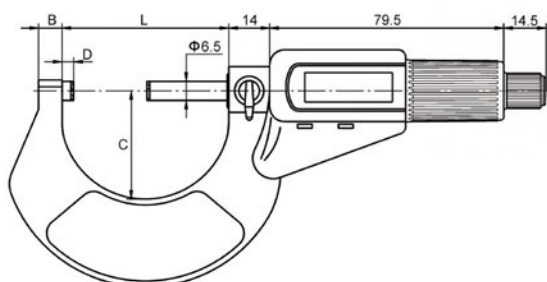
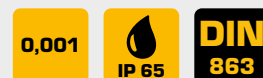

CODE	B [mm]	C [mm]	D [mm]	L [mm]	
7031-02-025	6	27,5	3	32	0 - 25 mm
7031-02-050	8	37,0	3	57	25 - 50 mm
7031-02-075	8	50,0	3	82	50 - 75 mm
7031-02-100	10	61,0	3	107	75 - 100 mm
7031-02-125	16	72,0	3	132	100 - 125 mm
7031-02-150	18	85,0	3	158	125 - 150 mm
7031-02-175	20	105,0	3	185	150 - 175 mm
7031-02-200	25	122,0	3	215	175 - 200 mm

Dodáváno včetně nastavovacího kalibru.  
 Supplied with Setting Gauge.  
 Dostarczamy wraz z krążkiem ustawiającym.



## Mikrometry | Micrometres | Mikrometry

Mikrometrický tloušťkoměr digitální  
Digital Thickness Gauge  
Grubościomierz elektroniczny

0,01

**DIN**  
863



CODE		d [mm]	
7040-1	0,01 mm	9	0 - 25 mm

Mikrometrický tloušťkoměr digitální ABZ  
Digital Thickness Gauge ABZ  
Grubościomierz elektroniczny ABZ

0,01

**DIN**  
863



CODE		d [mm]	
7040-05-010	0,01 mm	9	0 - 10/30 mm
7040-15-010	0,01 mm	9	0 - 10/120 mm

Mikrometr na trubky  
Tube Micrometer  
Mikrometer do rur

0,01

**DIN**  
863



CODE		
7041	0,01 mm	0-25 mm

Mikrometr na trubky digitální  
Digital Tube Micrometer  
Mikrometer elektroniczny do rur



0,001

**DIN**  
863



CODE	B [mm]	C [mm]	D [mm]	L [mm]		
7041-02-025	6,0	25,0	3,0	34,5	0,001 mm	0 - 25 mm
7041-02-050	8,0	32,0	3,0	59,5	0,001 mm	25 - 50 mm

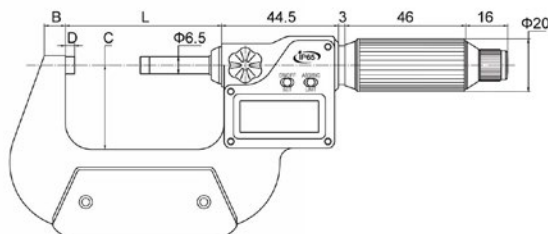

## Mikrometry | Micrometres | Mikrometry

Mikrometr na drát  
Wire Micrometer  
Mikrometer do drutu

0,01

ČSN  
25 1456



CODE



7043

0 - 10 mm

Mikrometr třmenový na ozubená kola  
Disc Micrometer  
Mikrometr do kól zębatých

0,01

ČSN  
25 1456



CODE

d [mm]



7051

20

0 - 25 mm

7052

20

25 - 50 mm

7053

20

50 - 75 mm

7054

20

75 - 100 mm

7055

30

100 - 125 mm

7056

30

125 - 150 mm

7057

30

150 - 175 mm

7058

30

175 - 200 mm

Mikrometr třmenový na ozubená kola - digitální NEW DESIGN  
Digital Disc Micrometer - NEW DESIGN  
Mikrometr do kól zębatých - elektroniczny NEW DESIGN

0,001

DIN  
863



CODE

d [mm]



7070-02-025

20

0 - 25 mm

7070-02-050

20

25 - 50 mm

7070-02-075

20

50 - 75 mm

7070-02-100

20

75 - 100 mm

7070-02-125

30

100 - 125 mm

7070-02-150

30

125 - 150 mm

7070-02-175

30

150 - 175 mm

7070-02-200

30

175 - 200 mm



## Mikrometry | Micrometres | Mikrometry

Mikrometr na zápichy  
Blade Micrometer  
Mikrometr do kanáľkóv zewnętrznych

0,01

DIN  
863

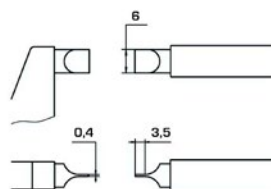
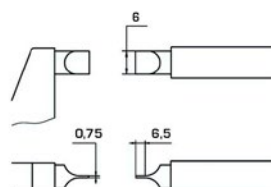

CODE	Range
7075-02-025	0 - 25 mm
7075-02-050	25 - 50 mm
7075-02-075	50 - 75 mm
7075-02-100	75 - 100 mm
7075-02-125	100 - 125 mm
7075-02-150	125 - 150 mm
7075-02-175	150 - 175 mm

CODE	Range
7076-02-025	0 - 25 mm

Mikrometr na zápichy - digitálny, rychloposuv  
Blade Micrometer 0,4x6mm  
Mikrometr do kanáľkóv zewnętrznych - elektroniczny, szybki



0,001

DIN  
863

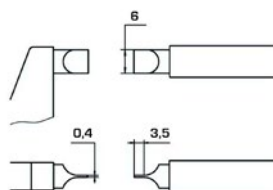
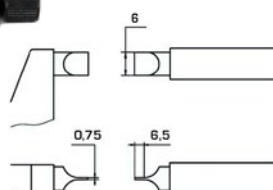

CODE	Range
7075-05-025	0 - 25 mm
7075-05-050	25 - 50 mm
7075-05-075	25 - 75 mm
7075-05-100	75 - 100 mm
7075-05-125	100 - 125 mm
7075-05-150	125 - 150 mm
7075-05-175	150 - 175 mm

CODE	Range
7076-05-025	0 - 25 mm

Mikrometr digitálny s hroty 30°  
Digital Blade Micrometer  
Mikrometr elektroniczny z końcówkami 30°

0,001

DIN  
863



CODE	Range
7077-05-025	0 - 25 mm

## Mikrometry | Micrometres | Mikrometry

Mikrometr dvoudotekový dutinový (dutinoměr)  
Internal Jaw Micrometer  
Mikrometr wewnętrzny

0,01

**DIN**  
863

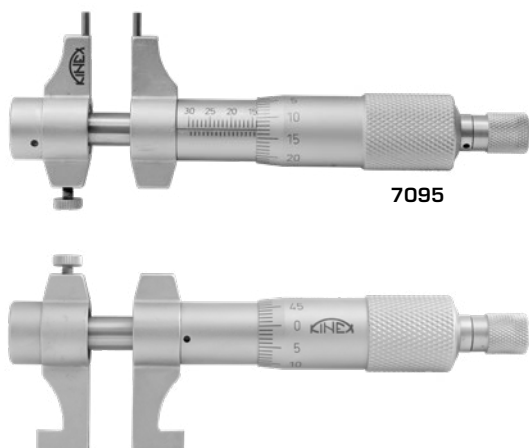

7095

CODE		0
7095	5 - 30 mm	5mm
7096	25 - 50 mm	25mm
7097	50 - 75 mm	-
7098	75 - 100 mm	-
7098-1	100 - 125 mm	-
7098-2	125 - 150 mm	-
7098-3	150 - 175 mm	-
7098-4	175 - 200 mm	-
7098-5	200 - 225 mm	-
7098-6	225 - 250 mm	-
7098-7	250 - 275 mm	-
7098-8	275 - 300 mm	-

Mikrometr dutinový dvoudotekový (dutinoměr) - digitální  
Digital Internal Jaw Micrometer  
Mikrometr wewnętrzny - elektroniczny

0,001

**DIN**  
863



7100-02-030

CODE		0
7100-02-030	5 - 30 mm	5mm
7100-02-050	25 - 50 mm	25mm
7100-02-075	50 - 75 mm	-
7100-02-100	75 - 100 mm	-

DALŠÍ ROZMĚRY NA ZAKÁZKU  
OTHER SIZES ON REQUEST  
INNE WYMIARY NA ZAMÓWIENIE

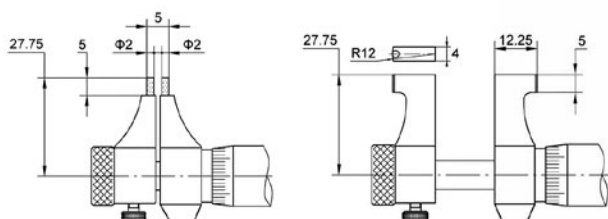





## Mikrometry | Micrometres | Mikrometry

Mikrometr třídotekový (dutinoměr) - SADA, NOVÝ MODEL V HLINÍKOVÉM KUFRU

3-point Internal Micrometer with Setting Rings - SET, NEW MODEL, Al box

Średnicówka mikrometryczna do małych otworów - ZESTAW, NOWY MODEL W ALUMINIOWEJ OBUDOWIE

0,001

DIN  
863



7089-03-040

CODE			sestava   zostava   zestaw	0
7089-03-003	0,004 mm	2 - 3 mm	2 - 2,5, 2,5 - 3 mm	2,5 mm
7089-03-006	0,004 mm	3 - 6 mm	3 - 4, 4 - 5, 5 - 6 mm	4, 5, 6 mm
7089-03-012	0,004 mm	6 - 12 mm	6 - 8, 8 - 10, 10 - 12 mm	6, 8, 10 mm
7089-03-020	0,004 mm	12 - 20 mm	12 - 16, 16 - 20 mm	16 mm
7089-03-040	0,004 mm	20 - 40 mm	20 - 25, 25 - 30, 30 - 40 mm	25, 40 mm
7089-03-100	0,005 mm	40 - 100 mm	40 - 50, 50 - 63, 62 - 75, 75 - 88, 87 - 100 mm	40, 62, 87 mm

7089-03-003, 7089-03-006 - pouze 2 doteky | only 2 touches | dwupunktowa

Mikrometr třídotekový (dutinoměr), NOVÝ MODEL V HLINÍKOVÉM KUFRU

3-point Internal Micrometer with Setting Rings - NEW MODEL, Al box

Średnicówka mikrometryczna do małych otworów, NOWY MODEL W ALUMINIOWEJ OBUDOWIE

D2 - 12  
0,001

D16 - 300  
0,005

DIN  
863



7090-89-040



7089-02-100

CODE			0
7089-02-002	0,004 mm	2 - 2,5 mm	2,5 mm
7089-02-003	0,004 mm	2,5 - 3 mm	2,5 mm
7089-02-004	0,004 mm	3 - 4 mm	4 mm
7089-02-005	0,004 mm	4 - 5 mm	5 mm
7089-02-006	0,004 mm	5 - 6 mm	6 mm
7089-02-008	0,004 mm	6 - 8 mm	6 mm
7089-02-010	0,004 mm	8 - 10 mm	8 mm
7089-02-012	0,004 mm	10 - 12 mm	10 mm
7089-02-016	0,004 mm	12 - 16 mm	16 mm
7089-02-020	0,004 mm	16 - 20 mm	16 mm
7089-02-025	0,004 mm	20 - 25 mm	25 mm
7089-02-030	0,004 mm	25 - 30 mm	25 mm
7089-02-040	0,004 mm	30 - 40 mm	40 mm
7089-02-050	0,005 mm	40 - 50 mm	40 mm
7089-02-063	0,005 mm	50 - 63 mm	62 mm
7089-02-075	0,005 mm	62 - 75 mm	62 mm
7089-02-088	0,005 mm	75 - 88 mm	87 mm
7089-02-100	0,005 mm	87 - 100 mm	87 mm
7089-02-125	0,005 mm	100 - 125 mm	-
7089-02-150	0,005 mm	125 - 150 mm	-
7089-02-175	0,005 mm	150 - 175 mm	-
7089-02-200	0,005 mm	175 - 200 mm	-
7089-02-225	0,007 mm	200 - 225 mm	-
7089-02-250	0,007 mm	225 - 250 mm	-
7089-02-275	0,007 mm	250 - 275 mm	-
7089-02-300	0,007 mm	275 - 300 mm	-

Mikrometry jsou dodávány včetně prodloužení 100 mm (do pr. 12 mm) nebo 150 mm (od pr. 12mm)

Micrometers are supplied with extension 100 mm (to ø 12mm) or 150 mm (from ø 12mm)

Mikrometry są dostarczane wraz z przedłużeniem 100 mm (do śred. 12 mm) lub 150 mm (od śred. 12 mm)

DALŠÍ ROZMĚRY NA ZAKÁZKU  
OTHER SIZES ON REQUEST  
INNE WYMIARY NA ZAMÓWIENIE

NEW  
LINE

## Mikrometry | Micrometres | Mikrometry

Mikrometr třídotekový (dutinoměr) digitální - AI box, SADA  
 3-point Digital Internal Micrometer with Setting Rings - SET, NEW MODEL, AI box  
 Średnicówka mikrometryczna trójpunktowa elektroniczna - AI box, ZESTAW



0,001



7090-03-100

CODE		prodl.   predí.   przedł.	0
7090-03-003	2 - 3 mm	2 - 2,5, 2,5 - 3 mm	2,5 mm
7090-03-006	3 - 6 mm	3 - 4, 4 - 5, 5 - 6 mm	4, 5, 6 mm
7090-03-012	6 - 12 mm	6 - 8, 8 - 10, 10 - 12 mm	6, 8, 10 mm
7090-03-020	12 - 20 mm	12 - 16, 16 - 20 mm	16 mm
7090-03-050	20 - 50 mm	20 - 25, 25 - 30, 30 - 40, 40 - 50 mm	25, 40 mm
7090-03-100	50 - 100 mm	50 - 63, 62 - 75, 75 - 88, 87 - 100 mm	62, 87 mm

7090-03-003, 7090-03-006 - pouze 2 doteky | only 2 touches | dwupunktowa

Mikrometr třídotekový (dutinoměr) digitální - AI box  
 3-point Digital Internal Micrometer with Setting Rings, NEW MODEL, AI box  
 Średnicówka mikrometryczna trójpunktowa elektroniczna - AI box



0,001



7090-02-088

CODE		0
7090-02-002	2 - 2,5 mm	2,5 mm
7090-02-003	2,5 - 3 mm	2,5 mm
7090-02-004	3 - 4 mm	4 mm
7090-02-005	4 - 5 mm	5 mm
7090-02-006	5 - 6 mm	6 mm
7090-02-008	6 - 8 mm	6 mm
7090-02-010	8 - 10 mm	8 mm
7090-02-012	10 - 12 mm	10 mm
7090-02-016	12 - 16 mm	16 mm
7090-02-020	16 - 20 mm	16 mm
7090-02-025	20 - 25 mm	25 mm
7090-02-030	25 - 30 mm	25 mm
7090-02-040	30 - 40 mm	40 mm
7090-02-050	40 - 50 mm	40 mm
7090-02-063	50 - 63 mm	62 mm
7090-02-075	62 - 75 mm	62 mm
7090-02-088	75 - 88 mm	87 mm
7090-02-100	87 - 100 mm	87 mm
7090-02-125	100 - 125 mm	-
7090-02-150	125 - 150 mm	-
7090-02-175	150 - 175 mm	-
7090-02-200	175 - 200 mm	-
7090-02-225	200 - 225 mm	-
7090-02-250	225 - 250 mm	-
7090-02-275	250 - 275 mm	-
7090-02-300	275 - 300 mm	-

Mikrometry jsou dodávány včetně prodloužení  
 100 mm (do pr. 12 mm) nebo 150 mm (od pr. 12 mm)

Micrometers are supplied with extension  
 100 mm (to  $\varnothing$  12mm) or 150 mm (from  $\varnothing$  12mm)

Mikrometry są dostarczane wraz z przedłużeniem  
 100 mm (do śred. 12 mm) lub 150 mm (od śred. 12 mm)

Mikrometry malých průměrů (do pr. 6 mm)  
 jsou dodávány pouze se 2 dotyky

Mikrometre malých priemerov (do pr. 6 mm)  
 sú dodávané iba s 2 dotykmi

Mikrometry o malých średnicach (do śred. 6 mm)  
 są dwupunktowe





## Mikrometry | Micrometres | Mikrometry

Mikrometr dutinový (dutinoměr) - analogový úchylkoměr  
Dial Bore Gauge with Dial Micrometer  
Średnicówka czujnikowa dwupunktowa - analogowa

**DIN**  
863





CODE		
7110-0	0,01 mm	6 - 10 mm
7110-1	0,01 mm	10 - 18 mm
7110-2	0,01 mm	18 - 35 mm
7110-3	0,01 mm	35 - 50 mm
7110-5	0,01 mm	50 - 160 mm
7110-6	0,01 mm	160 - 250 mm
7110-7	0,01 mm	250 - 450 mm

Mikrometr dutinový (dutinoměr) - digitální úchylkoměr  
Dial Bore Gauge with Digital Micrometer  
Średnicówka czujnikowa dwupunktowa - elektroniczna

**DIN**  
863





CODE		
7110-80	0,001 mm	6 - 10 mm
7110-81	0,001 mm	10 - 18 mm
7110-82	0,001 mm	18 - 35 mm
7110-83	0,01 mm	35 - 50 mm
7110-85	0,01 mm	50 - 160 mm
7110-86	0,01 mm	160 - 250 mm
7110-87	0,01 mm	250 - 450 mm

Mikrometr dutinový (dutinoměr) - analogový úchylkoměr  
Dial Bore Gauge with Dial Micrometer  
Średnicówka czujnikowa dwupunktowa - analogowa

**DIN**  
863





CODE		
7110-90	0,001 mm	6 - 10 mm
7110-91	0,001 mm	10 - 18 mm
7110-92	0,001 mm	18 - 35 mm
7110-93	0,001 mm	35 - 50 mm
7110-94	0,001 mm	50 - 160 mm
7110-95	0,001 mm	160 - 250 mm
 7110-96	0,001 mm	250 - 450 mm

Mikrometrické odpichy  
Internal Measurement Micrometer  
Średnicówka mikrometryczna składana

**DIN**  
863



CODE		
7125-12	0,01 mm	50 - 75 mm
7125	0,01 mm	50 - 600 mm
7125-3	0,01 mm	100 - 2100 mm
7125-1	nástavec   extension   przedłużenie	200 mm
7125-2	nástavec   extension   przedłużenie	100 mm

## Mikrometry | Micrometres | Mikrometry

Pasometr - Profesional  
Indicator Micrometer Professional  
Mikrometr z czujnikiem - Profesional

**DIN**  
863

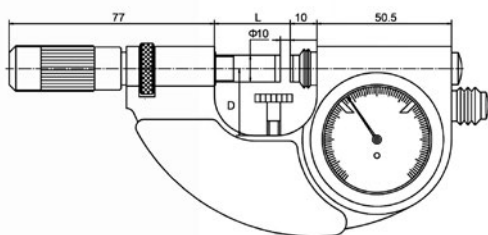

CODE	L [mm]	D [mm]		
7126-02-025	28,5	25,0	0,001 mm	0 - 25 mm
7126-02-050	53,5	35,0	0,001 mm	25 - 50 mm
7126-02-075	78,5	47,5	0,001 mm	50 - 75 mm
7126-02-100	103,5	60,0	0,001 mm	75 - 100 mm

Supplied with the Measuring Protocol.  
Dodávané vrátane protokolu o premeraní.  
Dostarczamy wraz z protokołem z pomiarzenia.

Pasometr (mikropasometr)  
Indicator Micrometer  
Mikrometr z czujnikiem

**DIN**  
863



CODE		
7126	0,001 mm	0 - 25 mm
7126-1	0,001 mm	25 - 50 mm
7126-2	0,001 mm	50 - 75 mm
7126-3	0,001 mm	75 - 100 mm

Mikrometrický hloubkoměr  
Depth Micrometer  
Głębokościomierz mikrometryczny

**DIN**  
863



7103-02-025



7103

CODE			
7103	0,01 mm	0 - 100 mm	analog
7103-02-025	0,001 mm	0 - 25 mm	digital

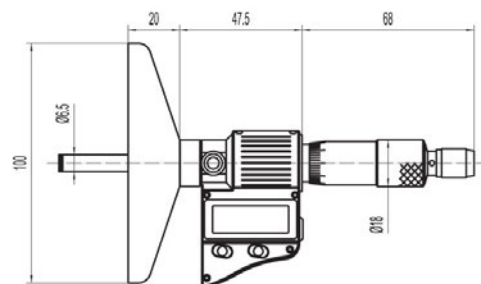



## Mikrometry | Mikrometre | Mikrometry

Mikrometrická hlavice  
Micrometer Head  
Głowica mikrometryczna

**DIN**  
863



CODE		
7120	0,01 mm	0 - 25 mm
7120-02-025	0,01 mm	0 - 25 mm krátké prov.   short version   wersja skrócona

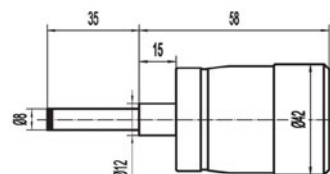

## Svinovací metry | Measuring Tapes | Miary zwijane

Svinovací metr KINEX - doporučujeme pro kalibrace  
Tape Measure KINEX - Recommended for Calibration  
Miara zwijana KINEX - zalecana do wzorcowania

**II**  
class  
**ČSN**  
25 1141



CODE		
8001	2 m	13 mm
8002	3 m	13 mm
8003	5 m	16 mm

Svinovací metr KINEX  
Tape Measure KINEX  
Miara zwijana KINEX

**CE**  
**I**  
class



CODE		
8002-02-003	3 m	13 mm
8002-02-005	5 m	19 mm
8002-02-008	8 m	25 mm
8002-02-010	10 m	25 mm

## Svinovací metry | Measuring Tapes | Miary zwijane

Svinovací metr KINEX Speciál  
Tape Measure KINEX Special  
Miara zwijana KINEX Special



CODE	— —	↔
8001-3	2 m	13 mm
8002-3	3 m	13 mm
8003-3	5 m	19 mm
8004-3	8 m	25 mm

Svinovací metr KOMELON - SELF LOCK, otěruvzdorná páska  
Tape Measure KOMELON - SELF LOCK, Resistant Tape  
Miara zwijana KOMELON - SELF LOCK, odporna na ścieranie



CODE	— —	↔
8039-3	3 m	16 mm
8039-5	5 m	19 mm

Svinovací metr KOMELON - PRO ERGO, otěruvzdorná páska  
Tape Measure KOMELON - PRO ERGO, Resistant Tape  
Miara zwijana KOMELON - PRO ERGO, odporna na ścieranie



CODE	— —	↔
8040-1	2 m	16 mm
8040-2	3 m	16 mm
8040-3	5 m	19 mm
8040-4	8 m	25 mm

Svinovací metr KOMELON, ECO PEN  
Tape Measure KOMELON, ECO PEN  
Miara zwijana KOMELON, ECO PEN



CODE	— —	↔
8041-2	3 m	16 mm
8042-2	5 m	19 mm
8043-2	8 m	25 mm



## Svinovací metry | Measuring Tapes | Miary zwijane

Svinovací metr FESTA - EEC cert., aut. brzda (autolock), pogumování  
Tape Measure FESTA - EEC cert., AUTOLOCK, Rubber Case  
Miara zwijana FESTA - EEC certyfikat, autolock, guma

Svinovací metr FESTA, pogumovaný s magnetem  
Tape Measure FESTA, Rubber Case, Magnet on Hook  
Miara zwijana FESTA, gumowana z magnesem



CODE	Length	Width
8044-20	3 m	16 mm
8044-21	5 m	19 mm
8044-22	7,5 m	25 mm

CODE	Length	Width
8044-10	2 m	16 mm
8044-11	3 m	16 mm
8044-12	5 m	19 mm
8044-13	7,5 m	25 mm
8044-14	10 m	25 mm

Diametr - svinovací metr pro měření průměru

Circumference Tape

Diametr - do pomiaru grubości



CODE	Length	Width
8005	2 m	10 mm



## Svinovací metry | Measuring Tapes | Miary zwijane

Svinovací metr JOHNEY  
Tape Measure JOHNEY  
Miara zwijana JOHNEY



CODE		
8040	2 m	13 mm
8041	3 m	13 mm
8042	5 m	13 mm
8042-1	5 m	19 mm
8043	7,5 m	19 mm

Svinovací metr FESTA - velké číslice  
Tape Measure FESTA - Large Numbers  
Miara zwijana FESTA - z dužými cyframi



CODE		
8044-15	2 m	16 mm
8044-16	3 m	19 mm
8044-17	5 m	19 mm

Svinovací metr KINEX HOBBY LINE II  
Tape Measure KINEX HOBBY LINE II  
Miara zwijana KINEX HOBBY LINE II



CODE		
8001-2	2 m	13 mm
8002-2	3 m	13 mm
8003-2	5 m	19 mm
8004-2	7,5 m	25 mm
8004-2-1	10 m	25 mm





## Pásma | Long Tapes | Miary zwijane

Pásmo KINEX - ocelová páska, pro kalibrace  
 Long Steel Tape KINEX - Recomm. for Calibration  
 Taśma stalowa zalecana do wzorcowania

ČSN  
25 1150

II  
class



CODE	-----	
8010	10 m	13 mm
8011	20 m	13 mm
8012	25 m	13 mm
8013	30 m	13 mm
8014	50 m	13 mm

Pásmo KINEX - ocelová páska, polyamid úprava  
 Long Steel Tape KINEX, polyamid  
 Taśma stalowa KINEX - polyamid

CE

I  
class



CODE	-----	
8017-02-030	30 m	13 mm
8017-02-050	50 m	13 mm

Pásmo KINEX s rukojetí, ocelová páska  
 Long Steel Tape KINEX with Handle  
 Taśma stalowa KINEX z uchwytem

ČSN  
25 1151

II  
class



CODE	-----	
8017	10 m	13 mm
8018	20 m	13 mm
8019	25 m	13 mm
8020	30 m	13 mm
8021	50 m	13 mm

Pásmo KOMELON ve vidlici, sklo-laminátová el. nevodivá páska  
 Long Steel Tape Komelton KOMELON - Laminate Tape  
 Taśma KOMELON - widełki, szkło i laminat, nieprzewodząca prąd elektr.

CE



CODE	-----	
8054-0	30 m	13 mm
8054-1	50 m	13 mm
8054	100 m	13 mm

## Pásma | Long Tapes | Miary zwijane

Pásma KOMELON - sklo-laminátová páska  
Long Tape KOMELON - Laminat  
Taśma KOMELON szkło - laminat



CODE	Length	Width
8045	10 m	13 mm
8046	20 m	13 mm
8047	30 m	13 mm
8048	50 m	13 mm

Pásma KOMELON, ocelová páska  
Long Steel Tape KOMELON  
Taśma stalowa KOMELON



CODE	Length	Width
8055	10 m	10 mm
8055-1	20 m	10 mm
8055-2	30 m	10 mm

Pásma KINEX Hobby line I, ocelová páska  
Long Steel Tape FESTA with tiltable hook  
Taśma stalowa KINEX - HOBBY LINE I



CODE	Length	Width
8050	10 m	10 mm
8051	20 m	10 mm
8052	30 m	10 mm
8053	50 m	10 mm

Měřicí kolečko  
Long Steel Tape KINEX Hobby line I  
Drogomierz



8057-02-300

8057-15-320

CODE	Length	Width	Weight	Diameter	Type
8057-02-300	1010 / 510 mm	1530g	D 318 mm	analog	
8057-15-320	1100 / 620 mm	1700g	D 318 mm	digital	

Páska s mm dělením rovná ke strojům 3m  
Steel Tape with mm graduation for Machines - 3m  
Taśma z mm podziałką 3m



CODE	Length	Width
8002-10	3 m	13 mm

Na zakázku nabízíme dodání pásky v různých délkách, v bílém nebo žlutém provedení, se stupnicí zleva doprava i zprava doleva.

We offer custom delivery tapes in various lengths, in white or yellow design, with a scale from left to right and right to left.

Oferujemy niestandardowe taśmy w różnych długościach, w kolorze białym lub żółtym w wersji ze skalą od lewej do prawej lub od prawej do lewej.



## Sady | Sady | Zestawy

Prezentační sada v boxu  
Presentation Set in boxing  
Reprezentacyjny box produktów

**NEW  
LINE**



### CODE

7171-01-006

sada obsahuje:  
set contains:  
zestaw zawiera:

6040-27-150

6040-05-150

1155-05-010

7030-27-030

7030-05-025

4026-28-006

Sada mezních válečkových kalibrů  
Set of Plug Gauges  
Zestaw sprawdzianów do gwintów metrycznych

**NEW  
LINE**



### CODE

92000-H7-012

sada obsahuje:  
set contains:  
zestaw zawiera:

92003H7 3H7

92004H7 4H7

92005H7 5H7

92006H7 6H7

92008H7 8H7

92010H7 10H7

92012H7 12H7

Sada mezních závitových kroužků  
Set of Thread Ring Gauges  
Zestaw mierników gwintowanych, pierścienie

**NEW  
LINE**



### CODE

94000-6g-12D

94000-6g-12Z

sada obsahuje:  
set contains:  
zestaw zawiera:

94003-6g M3

94004-6g M4

94005-6g M5

94006-6g M6

94008-6g M8

94010-6g M10

94012-6g M12

Sada mezních závitových trnů  
Set of Thread Plug Gauges  
Zestaw sprawdzianów, szpilki gwintowane

**NEW  
LINE**



### CODE

93000-6H-012

sada obsahuje:  
set contains:  
zestaw zawiera:

93003-6H M3

93004-6H M4

93005-6H M5

93006-6H M6

93008-6H M8

93010-6H M10

93012-6H M12

Sada zámečnických příložných úhelníků  
Try Squares Set  
Zestaw kątowników ze stopką

**NEW  
LINE**



### CODE

S444-43-250

sada obsahuje:  
set contains:  
zestaw zawiera:

4020

4021

4022

Sada měřidel  
Measuring Tools Set  
Zestaw uniwersalny

**NEW  
LINE**



### CODE

S678-32-0001

sada obsahuje:  
set contains:  
zestaw zawiera:

6000

7002

8001

## Kalibry | Gauges | Sprawdziany

Nastavovací kroužek DIN2250C  
Setting Ring DIN 2250 C  
Sprawdzian pierścieniowy DIN2250C



CODE	
91002	D 2 mm
91002,5	D 2,5 mm
91003	D 3 mm
91003,5	D 3,5 mm
91004	D 4 mm
91004,5	D 4,5 mm
91005	D 5 mm
91006	D 6 mm
91007	D 7 mm
91008	D 8 mm
91009	D 9 mm
91010	D 10 mm
91011	D 11 mm
91012	D 12 mm
91013	D 13 mm
91014	D 14 mm
91015	D 15 mm
91016	D 16 mm
91017	D 17 mm
91018	D 18 mm
91019	D 19 mm
91020	D 20 mm
91022	D 22 mm
91024	D 24 mm
91025	D 25 mm
91026	D 26 mm
91027	D 27 mm
91028	D 28 mm
91029	D 29 mm
91030	D 30 mm
91032	D 32 mm
91033	D 33 mm
91034	D 34 mm
91035	D 35 mm

CODE	
91036	D 36 mm
91038	D 38 mm
91040	D 40 mm
91042	D 42 mm
91044	D 44 mm
91045	D 45 mm
91046	D 46 mm
91050	D 50 mm
91055	D 55 mm
91060	D 60 mm
91065	D 65 mm
91070	D 70 mm
91075	D 75 mm
91080	D 80 mm
91085	D 85 mm
91090	D 90 mm
91095	D 95 mm
91100	D 100 mm
91112,5	D 112,5 mm
91125	D 125 mm
91137,5	D 137,5 mm
91150	D 150 mm
91162,5	D 162,5 mm
91175	D 175 mm
91187,5	D 187,5 mm
91200	D 200 mm
91225	D 225 mm
91250	D 250 mm
91275	D 275 mm
91300	D 300 mm



**Kompletní sortiment kalibrů v samostatném katalogu!**  
**Complete range of Gauges in separate catalog!**  
**Kompletny asortyment sprawdzianów w oddzielnym katalogu!**  
**ONLINE: [www.kinexmeasuring.com/KATALOG\\_KALIBRY\\_CZSKPL.pdf](http://www.kinexmeasuring.com/KATALOG_KALIBRY_CZSKPL.pdf)**



## Kalibry | Gauges | Sprawdziany

Mezní válečkový kalibr DIN 7162, DIN 7164

Plug Gauge DIN 7162, DIN 7164

Sprawdzian graniczny tłoczkowy DIN 7162, DIN 7164



Řada kalibrů H8 skladem  
Gauges series H8 in stock  
Sprawdziany serii H 8 w magazynie

CODE	
92002H7	D 2 H7
92002,5H7	D 2,5 H7
92003H7	D 3 H7
92004H7	D 4 H7
92005H7	D 5 H7
92006H7	D 6 H7
92007H7	D 7 H7
92008H7	D 8 H7
92009H7	D 9 H7
92010H7	D 10 H7
92011H7	D 11 H7
92012H7	D 12 H7
92013H7	D 13 H7
92014H7	D 14 H7
92015H7	D 15 H7
92016H7	D 16 H7
92017H7	D 17 H7
92018H7	D 18 H7
92019H7	D 19 H7
92020H7	D 20 H7
92021H7	D 21 H7
92022H7	D 22 H7
92023H7	D 23 H7
92024H7	D 24 H7
92025H7	D 25 H7
92026H7	D 26 H7
92027H7	D 27 H7
92028H7	D 28 H7
92029H7	D 29 H7
92030H7	D 30 H7

CODE	
92031H7	D 31 H7
92032H7	D 32 H7
92033H7	D 33 H7
92034H7	D 34 H7
92035H7	D 35 H7
92036H7	D 36 H7
92037H7	D 37 H7
92038H7	D 38 H7
92039H7	D 39 H7
92040H7	D 40 H7
92041H7	D 41 H7
92042H7	D 42 H7
92043H7	D 43 H7
92044H7	D 44 H7
92045H7	D 45 H7
92046H7	D 46 H7
92047H7	D 47 H7
92048H7	D 48 H7
92050H7	D 50 H7
92052H7	D 52 H7
92055H7	D 55 H7
92060H7	D 60 H7
92065H7	D 65 H7
92070H7	D 70 H7
92075H7	D 75 H7
92080H7 *	D 80 H7
92085H7 *	D 85 H7
92090H7 *	D 90 H7
92095H7 *	D 95 H7
92100H7 *	D 100 H7

\* dobrá i zmetková strana se samostatnou rukojetí

\* Go and NoGo side with separate handle

\* przechodnia i nieprzechodnia część z oddzielnym uchwytem

## Kalibry | Gauges | Sprawdziany

Mezní závitový trn - Metrický závit M, DIN 13  
 Thread Plug Gauge - Metric Thread M, DIN 13  
 Sprawdzian graniczny do gwintów metrycznych M, DIN 13



CODE	
93002-6H	D M2- 6H
93002,5-6H	D M2,5- 6H
93003-6H	D M3- 6H
93003,5-6H	D M3,5- 6H
93004-6H	D M4- 6H
93004,5-6H	D M4,5- 6H
93005-6H	D M5- 6H
93006-6H	D M6- 6H
93007-6H	D M7- 6H
93008-6H	D M8-6H
93009-6H	D M9-6H
93010-6H	D M10- 6H
93012-6H	D M12- 6H
93014-6H	D M14- 6H
93016-6H	D M16- 6H
93018-6H	D M18- 6H
93020-6H	D M20- 6H
93022-6H	D M22- 6H
93024-6H	D M24- 6H
93027-6H	D M27- 6H
93030-6H	D M30- 6H
93033-6H	D M33- 6H
93036-6H	D M36- 6H
93039-6H	D M39- 6H
93042-6H	D M42- 6H
93045-6H	D M45- 6H
93048-6H	D M48- 6H

Mezní závitový trn - trubkový závit G, DIN EN ISO 228  
 Thread Plug Gauge - Pipe Thread G, DIN EN ISO 228  
 Sprawdzian graniczny do gwintów rurowych G, DIN EN ISO 228



CODE	
93301	G 1/16"
93302	G 1/8"
93303	G 1/4"
93304	G 3/8"
93305	G 1/2"
93306	G 5/8"
93307	G 3/4"
93308	G 7/8"
93309	G 1"
93310	G 1 1/8"
93311	G 1 1/4"
93312	G 1 1/2"
93313	G 1 3/4"
93314	G 2"
93315	G 2 1/4"
93316	G 2 1/2"
93317	G 2 3/4"
93318 *	G 3"
93319 *	G 3 1/2"
93320 *	G 4"
93321 *	G 4 1/2"
93322 *	G 5"
93323 *	G 5 1/2"
93324 *	G 6"

- \* dobrá i zmetková strana se samostatnou rukojetí
- \* Go and NoGo side with separate handle
- \* przechodnia i nieprzechodnia część z oddzielnym uchwytem

Jemné stoupání závitových kalibrů skladem

Fine-pitch Gauges in stock

Sprawdziany o małym skoku gwintu posiadamy na magazynie



## Kalibry | Gauges | Sprawdziany

Mezní závitový kroužek - dobrý, DIN 13  
Thread Ring Gauge - Metric Thread - Go, DIN 13  
Sprawdzian pierścieniowy do gwintów metrycznych - przechodni, DIN 13



CODE	
94002-6gD	D M2-6g
94002,5-6gD	D M2,5-6g
94003-6gD	D M3-6g
94003,5-6gD	D M3,5-6g
94004-6gD	D M4-6g
94005-6gD	D M5-6g
94006-6gD	D M6-6g
94007-6gD	D M7-6g
94008-6gD	D M8-6g
94009-6gD	D M9-6g
94010-6gD	D M10-6g
94012-6gD	D M12-6g
94014-6gD	D M14-6g
94016-6gD	D M16-6g
94018-6gD	D M18-6g
94020-6gD	D M20-6g
94022-6gD	D M22-6g
94024-6gD	D M24-6g
94027-6gD	D M27-6g
94030-6gD	D M30-6g
94033-6gD	D M33-6g
94036-6gD	D M36-6g
94039-6gD	D M39-6g
94042-6gD	D M42-6g
94045-6gD	D M45-6g
94048-6gD	D M48-6g

Mezní závitový kroužek - trubkový závit G, dobrý, DIN EN ISO 228  
Thread Ring Gauge - Pipe Thread G, Go, DIN EN ISO 228  
Sprawdzian do gwintów metrycznych G - przechodni, DIN EN ISO 228



CODE	
94301D	G 1/16"
94302D	G 1/8"
94303D	G 1/4"
94304D	G 3/8"
94305D	G 1/2"
94306D	G 5/8"
94307D	G 3/4"
94308D	G 7/8"
94309D	G 1"
94310D	G 1 1/8"
94311D	G 1 1/4"
94312D	G 1 1/2"
94313D	G 1 3/4"
94314D	G 2"
94315D	G 2 1/4"
94316D	G 2 1/2"
94317D	G 2 3/4"
94318D	G 3"

**Jemné stoupání kalibrů skladem**  
**Fine Pitch Gauges in stock**  
**Sprawdziany o małym skoku gwintu posiadamy na magazynie**

## Kalibry | Gauges | Sprawdziany

Mezní závitový kroužek - zmetkový, DIN 13  
 Thread Ring Gauge - Metric Thread - NoGo, DIN 13  
 Sprawdzian pierścieniowy do gwintów metrycznych - nieprzechodni, DIN 13

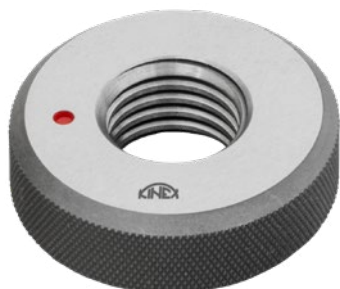

CODE	
94002-6gZ	D M2-6g
94002,5-6gZ	D M2,5-6g
94003-6gZ	D M3-6g
94003,5-6gZ	D M3,5-6g
94004-6gZ	D M4-6g
94005-6gZ	D M5-6g
94006-6gZ	D M6-6g
94007-6gZ	D M7-6g
94008-6gZ	D M8-6g
94009-6gZ	D M9-6g
94010-6gZ	D M10-6g
94012-6gZ	D M12-6g
94014-6gZ	D M14-6g
94016-6gZ	D M16-6g
94018-6gZ	D M18-6g
94020-6gZ	D M20-6g
94022-6gZ	D M22-6g
94024-6gZ	D M24-6g
94027-6gZ	D M27-6g
94030-6gZ	D M30-6g
94033-6gZ	D M33-6g
94036-6gZ	D M36-6g
94039-6gZ	D M36-6g
94042-6gZ	D M42-6g
94045-6gZ	D M45-6g
94048-6gZ	D M48-6g

Mezní závitový kroužek - trubkový závit G, zmetkový, DIN EN ISO 228  
 Thread Ring Gauge - Pipe Thread G, NoGo, DIN EN ISO 228  
 Sprawdzian do gwintów metrycznych G - nieprzechodni, DIN EN ISO 228



CODE	
94301Z	G 1/16"
94302Z	G 1/8"
94303Z	G 1/4"
94304Z	G 3/8"
94305Z	G 1/2"
94306Z	G 5/8"
94307Z	G 3/4"
94308Z	G 7/8"
94309Z	G 1"
94310Z	G 1 1/8"
94311Z	G 1 1/4"
94312Z	G 1 1/2"
94313Z	G 1 3/4"
94314Z	G 2"
94315Z	G 2 1/4"
94316Z	G 2 1/2"
94317Z	G 2 3/4"
94318Z	G 3"



Široký sortiment kalibrů skladem  
 Wide range of Gauges in stock  
 Różnego typu sprawdz. mamy na magazynie  
**BSW, UNC, UN(E)F, TR, Pg, Rp / R, NPT(F)**

Kompletní sortiment kalibrů v samostatném katalogu!  
 Complete range of Gauges in separate catalog!  
 Kompletny asortyment sprawdzianów w oddzielnym katalogu!  
 ONLINE: [www.kinexmeasuring.com/KATALOG\\_KALIBRY\\_CZSKPL.pdf](http://www.kinexmeasuring.com/KATALOG_KALIBRY_CZSKPL.pdf)





## Doplňkový sortiment | Additional assortment | Dodatkowy asortyment

Úhelník dřevěný, stolařský  
Wooden Square  
Kątownik drewniany stolarski



CODE	↔
4065	300x250 mm
4066	400x200 mm
4067	500x250 mm

Kosořez dřevěný 280x90x60mm/60°  
Wooden Angle Holder 280x90x60mm/60°  
Drewniany szablon do skosów



CODE	↔	↔
9001	60°	280x90x60 mm

Úhloměr dřevěný 250mm/30°,45°,60°,90°  
Úhlomer drevený 250mm/30°,45°,60°,90°  
Kątomierz drewniany



CODE	↔	↔
9002	30°, 45°, 60° a 90°	250 mm

Úhloměr dřevěný 250mm/30°,45°,60°,90°  
Úhlomer drevený 250mm/30°,45°,60°,90°  
Kątomierz drewniany



CODE	↔
9003	250x100 mm

Pravítko KINEX cejchované 1m - pro prodejny a provozy s metráží  
Bevel Protractor - Wooden Type  
Przymiar drewniany cechowany - dla sklepów i do operacji z metrazem



CODE	↔	↔
1072	1 m	35x9 mm

Platnost cejchu od státní zkušebny je daný rok + dva následující.  
The validity of the mark from the State Examination Office  
is given year + two following.

Ważność miary po badaniach państwowych na rok + dwa następujące.

Měřítko dřevěné  
Wooden Rule  
Przymiar drewniany

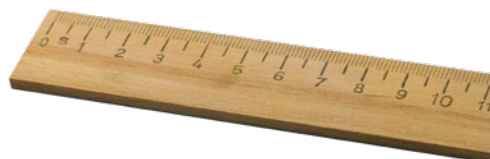

CODE	↔	↔
1070-02-030	300 mm	35x7mm
1070-02-050	500 mm	35x7mm
1070-02-100	1000 mm	37x6mm

## Doplňkový sortiment | Additional assortment | Dodatkowy asortyment

Měřicí teleskopická tyč  
Telescopic Measuring 3m  
Przymiar teleskopowy



CODE	
1054	3 m
1055	5 m
1056	8 m

Skládací dřevěný metr PROFI  
Wooden Folding Ruler  
Miara składana drewniana z obrzeżem metalowym PROFI



CODE		
8060	1 m	16 mm
8065	2 m	16 mm
8067	3 m	16 mm

Krejčovský metr samonavíjecí 1,5m  
Tailor Tape automatic 1,5m  
Metr krawiecki rozwijany 1,5m



CODE	
8074	1,5 m

Skládací plastový metr  
Plastic Folding Ruler  
Miara składana z tworzywa



CODE		
8070	1 m	15 mm
8071	2 m	15 mm

Dálkoměr laserový PD23  
Laser Distancer PD23  
Dalmierz laserowy PD23



CODE		
9040-700	30 m	± 2 mm

Dálkoměr laserový - PROFESSIONAL  
Digital Laser Distance Meter 50m - NEW DESIGN  
Dalmierz laserowy - PROFESSIONAL



CODE		
9040-02-050	50 m	± 2 mm
9040-02-060	60 m	± 2 mm
9040-02-070	70 m	± 2 mm
9040-02-080	80 m	± 2 mm
9040-02-100	100 m	± 2 mm



## Doplňkový sortiment | Additional assortment | Dodatkowy asortyment

Samonivelační křížový laser, horizontální a vertikální paprsek  
Cross Laser KINEX - Autolevel, Magnetic Holder  
Samopozimujący laser krzyżowy, promień poziomy i pionowy



### CODE

9040-900

10 m

± 1 mm/1m

1x vertikální + 1 horizontální paprsek + 5x bod  
1x vertical + 1x horizontal beam + 5x point  
1x pionowy + 1x poziomy promień + 5x punkt

Samonivelační křížový laser LP103, horizontální a vertikální paprsek  
Laser LP103 Cross Laser, horizontal and vertical beam  
Samopozimujący laser krzyżowy LP103, promień poziomy i pionowy



### CODE

9040-935

15 m

± 1 mm/1m

1x vertikální + 1 horizontální paprsek  
1x vertical + 1x horizontal beam  
1x pionowy + 1x poziomy promień

## Lasery



# baublys

Made in Germany

## LASER vláknový

### MOŽNÉ APLIKACE POPISU MATERIÁLU

UV popis pro automatické linky  
povrchová úprava  
mikro popis  
popis žháním  
gravírování / rytí  
barevné popisy

Stolní laser **Baublys BL2000** je vybaven nejmodernějším vláknovým laserem s dlouhou životností. Je vybaven na velmi kompaktním prostoru stejnou efektivní technologií jako naše průmyslové značení a rytí.

Systémový software je snadno ovladatelný, flexibilní a nabízí optimální řešení pro kvalitní značení na různých materiálech (plasty, kompozitní materiály, keramika, kov a další). Vše v nejlepší poměru cena/výkon.

**BL2000** je bezúdržbový a vyžaduje pouze obvyklou zásuvku na 230V.

### HMI Interface

Kompletní nově navržený a vyvinutý operační systém HMI s dotykovou obrazovkou. Ovládací a programovací software je založen na systému Windows 7 / Windows 10. Dlouholetá zkušenost s aplikací gravírování a značení zajišťuje intuitivní a jednoduché programování.

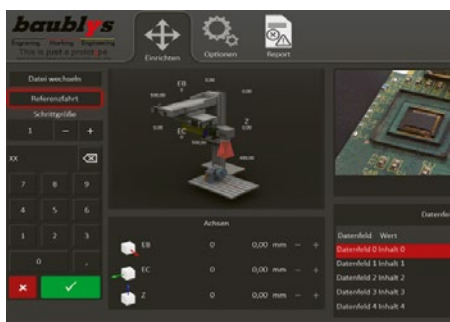

### Profesionální upínání materiálu

Pro profesionální polohování a kalibraci obrobku.



### Odvod spalin

Výkonné zařízení pro odsávání kouře a prachu.

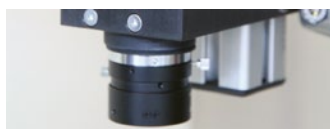

### Kamerové systémy

Kamerový systém ke sledování pracovního procesu.



### Optické vlastnosti

Různé verze optiky umožňují přizpůsobit oblast popisu, a kvalitu rozlišení.

## SPECIFIKACE VÝROBKU

Typ laseru	Ytterbiuové vlákno	Ovládání	CNC control
Vlnová délka laseru	1064 nm	System software	Windows 7 / Windows 10
Pulsní frekvence	20 - 200 kHz	Rozměry (D x Š x V)	800 x 600 x 900 mm
Napájení	10 - 100 W	Připojení k síti	Ano
Oblast popisu	180 x 180 mm		

[www.elaser.sk](http://www.elaser.sk)

+420 724 486 318  
lasery@kinexmeasuring.com  
<http://www.kinexmeasuring.com>



# baublys

Made in Germany

## LASER vláknový

### MOŽNÉ APLIKACE POPISU MATERIÁLU

UV popis pro automatické linky  
 povrchová úprava  
 mikro popis  
 popis žháním  
 gravírování / rytí  
 barevné popisy

**Kompaktní, robustní, spolehlivý**, to jsou vlastnosti řady **BL3000**. Stroj je vyroben na základě osvědčených řešení, spárovaný s nejnovějšími laserovými technologiemi. Extrémně atraktivní poměr cena / výkon. Velký prostor pro zpracování materiálu, zvyšuje flexibilitu uživatele.

Všechny technologické procesy lze provádět univerzálně a to ve všech typech materiálů. Pro tento stroj jsou k dispozici všechny typy a výkonnosti laserů.



### HMI Interface

Ovládací software byl zaměřen tak, aby jej zvládli běžní zaměstnanci v provozu výroby a zároveň modulárně postavený tak, aby byla možná další rozšíření aplikací pro složitější implementace - například na automatické lince.



### Optika

Různé verze optiky umožňují přizpůsobit oblast popisu a kvalitu rozlišení.

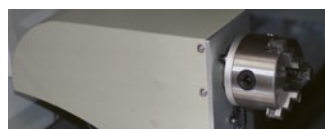

### Indexování příloh

Malé a kompaktní pro standardní popisy nebo rotační aplikace asymetrických součástí.



### Modul čárového kódu

Pro snadné a pohodlné vytváření kódů a následné označování obrobků.



### Odvod zplodin

Výkonné zařízení pro extrakci organických a anorganických částic.

### MODULÁRNÍ MOŽNOSTI LASERU BL3000

Typ laseru	UV laser	zelený laser	vláknový laser	CO2 laser
Vlnová délka laseru	355 nm	532 nm	1064 nm	10,6 μm
Pulsní frekvence	10 - 200 kHz	10 - 200 kHz	20 - 200 kHz	cw
Napájení	3 - 8 W	10 - 20 W	10 - 50 W	10 - 50 W
Oblast popisu	na vyžádání	max. 160 x 160 mm	max. 160 x 160 mm	max. 300 x 300 mm
Ovládání			NC control	
System software			Windows 7	
Rozměry (D x Š x V)			800 x 1148 x 1750 mm	
Připojení k síti			Ano	

# BEZDRÁTOVÉ MĚŘENÍ



Iconic Space

## DIGITALIZACE MĚŘENÍ JEDNODUŠE VE 3 KROCÍCH



**BEZDRÁTOVÁ  
MĚŘIDLA**

**AUTOMATICKÝ  
SBĚR DAT**

**STATISTICKÁ  
REGULACE PROCESU**

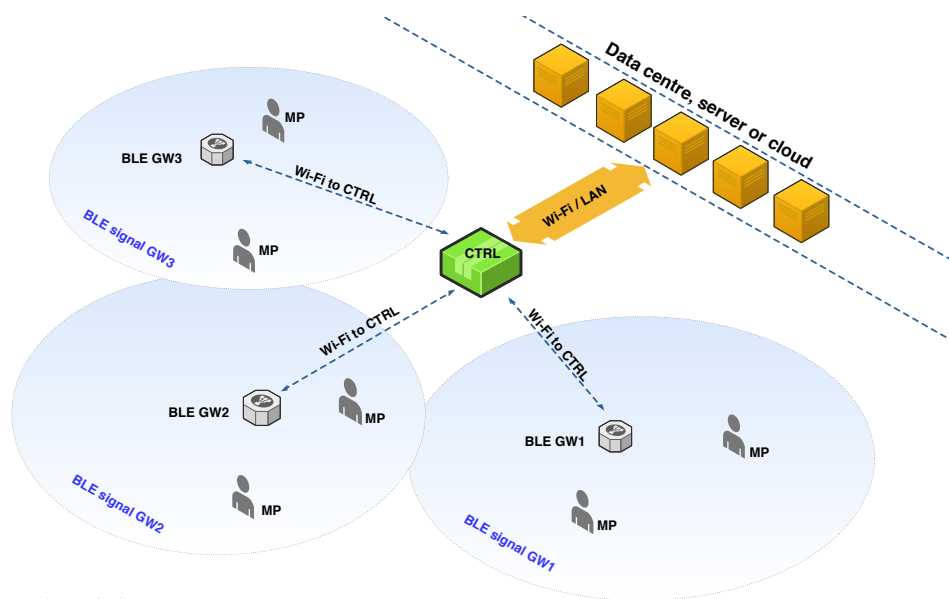

**BLE signál** - signál pro připojení měřidel  
**BLEGW (1, 2, 3)** - Bluetooth Gateway  
**MP** - měřicí pracoviště  
**CTRL** - Kontrolér  
**BLEGW** - Gateway přenáší data do CTRL nebo přímo do Wi-Fi sítě, zajišťuje automatické připojení měřidla, umožňuje roaming, dálková správa  
**CTRL** - Kontrolér přenáší data z BLEGW do aplikací, řídí a konfiguruje všechny BLEGW univerzální formát dat na výstupu, hostuje aplikace jako je SPC atd., dálková správa

**KINEX Measuring s.r.o.**  
 Podnikatelská 586, 190 11 Praha 9  
 +420 724 486 318  
 ispace@kinexmeasuring.com

### STÁVAJÍCÍ DOKUMENTACE

Použijete vaše výkresy, kontrolní plány, případně jiné podklady v papírové nebo digitální podobě.

### DIGITALIZACE PRACOVISŤE

Dodáme bezdrátová měřidla a digitální infrastrukturu, integrujeme do vašeho procesu.

### SPC V REÁLNÉM ČASE

Naše SPC aplikace vytvoří regulační diagramy a histogramy v reálném čase nebo můžeme data integrovat přímo do vašeho existujícího systému.

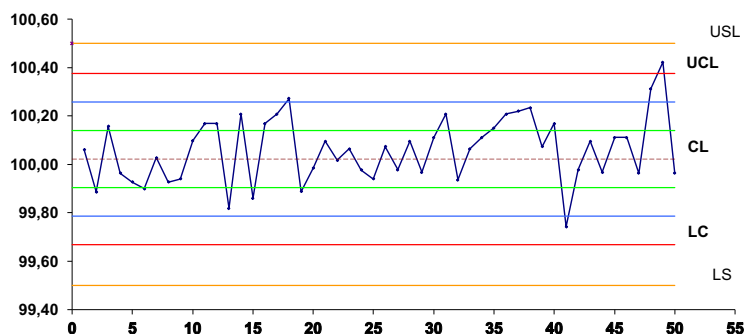



## WIRELESS MEASUREMENT



# Iconic Space

### DIGITIZATION OF MEASUREMENTS SIMPLY IN 3 STEPS



**WIRELESS  
GAUGES**

**AUTOMATICALLY  
DATA COLLECTION**

**STATISTICAL  
PROCESS REGULATION**

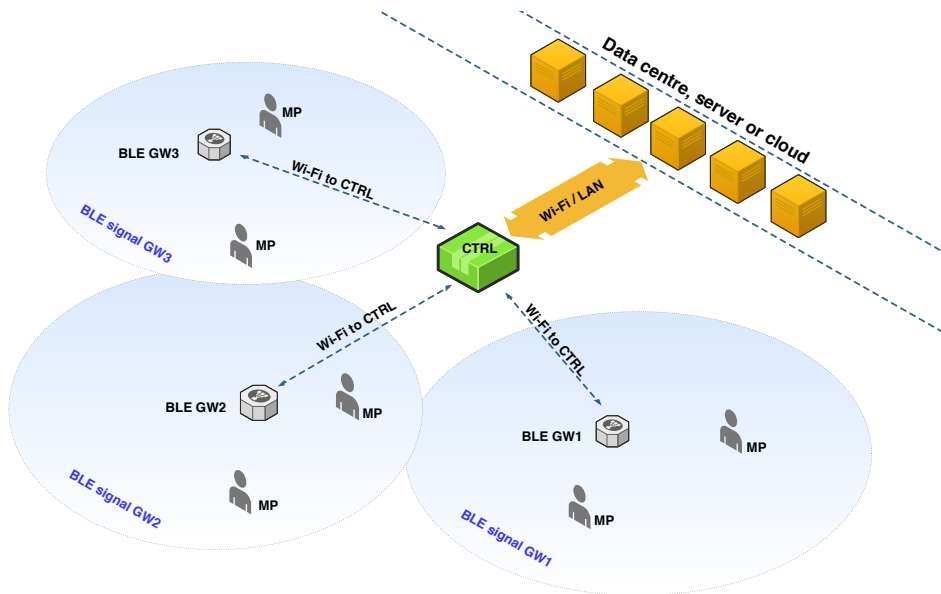

**BLE signal** - signal for connecting meters  
**BLEGW (1, 2, 3)** - Bluetooth Gateway  
**MP** - measuring workplace  
**CTRL** - Kontrolér  
**BLEGW** - Gateway transmits data to CTRL or directly to a Wi-Fi network ensures automatic connection of the meter; allows roaming, remote management  
**CTRL** - Controller transfers data from BLEGW to applications, manages and configures all BLEGW universal output data formats, hosts applications such as SPC, etc., remote management

**KINEX Measuring s.r.o.**  
 Podnikatelská 586, 190 11 Praha 9  
 +420 724 486 318  
 ispace@kinexmeasuring.com

#### EXISTING DOCUMENTATION

Use your drawings, control plans or other documents in paper or digital form.

#### DIGITIZATION OF WORKPLACE

We deliver wireless meters and digital infrastructure, integrate into your process.

#### SPC IN REAL TIME

Our SPC application creates control charts and histograms in real time or can integrate data directly into your existing system.

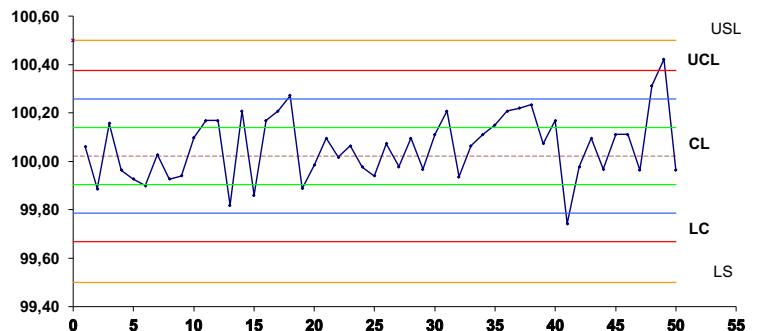

# POMIAR BEZPRZEWODOWY



Iconic Space



## PROSTA DYGTALIZACJA POMIARU W 3 KROKACH

**BEZPRZEWODOWE URZĄDZENIA POMIAROWE**

**AUTOMATYCZNY ZBIÓR DANYCH**

**STATYSTYCZNA REGULACJA PROCESU**

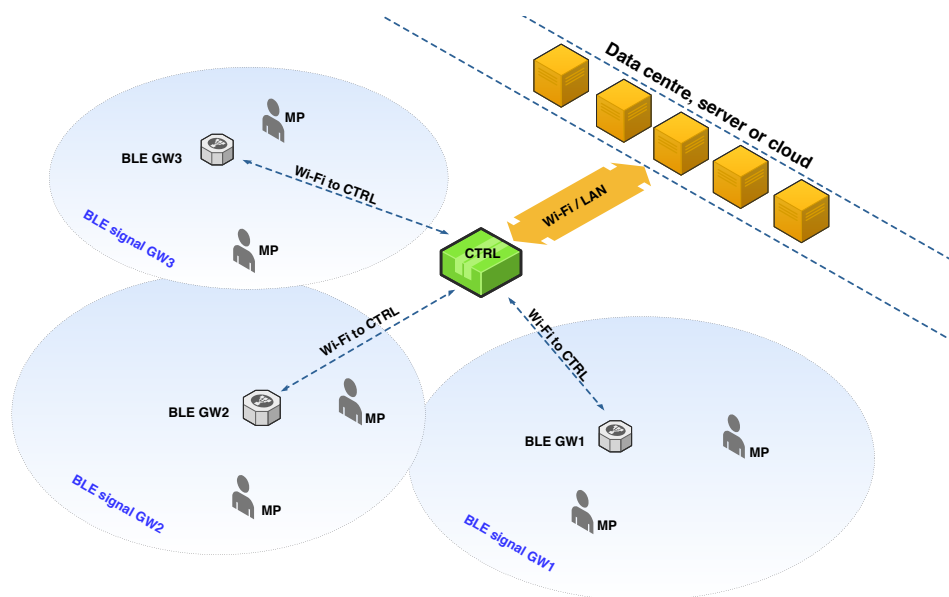

**BLE sygnał** - sygnał do podłączenia urządzeń  
**BLEGW (1, 2, 3)** - Bluetooth Gateway  
**MP** - miejsce pomiaru  
**CTRL** - Kontroler  
**BLEGW** - Gateway przesyła dane do CTRL lub bezpośrednio do sieci WiFi, zapewnia automatyczne połączenie urządzeń, umożliwia roaming, przesłanie danych  
**CTRL** - Kontroler przesyła dane z BLEGW do aplikacji, kieruje i konfiguruje wszystkie BLEGW, uniwersalny format danych na wyjściu, jest hostem aplikacji jak np. SPC itd., przesyła dane

**KINEX Measuring s.r.o.**

Podkátelská 586, 190 11 Praha 9  
 +420 724 486 318  
 ispace@kinexmeasuring.com

### DOTYCHCZASOWA DOKUMENTACJA

Wykorzystajcie Państwo dotychczasową dokumentację (wykres, plan kontrolny) w papierowej lub dygitalnej postaci.

### DYGTALIZACJA MIEJSCA PRACY

Dostarczymy urządzenia do pomiaru bezprzewodowego oraz zainstalujemy infrastrukturę dygitalną.

### SPC W CZASIE RZECZYWISTYM

Nasza aplikacja SPC wytworzy regulujące diagramy i histogramy w czasie rzeczywistym lub może integrować dane bezpośrednio do Waszego systemu

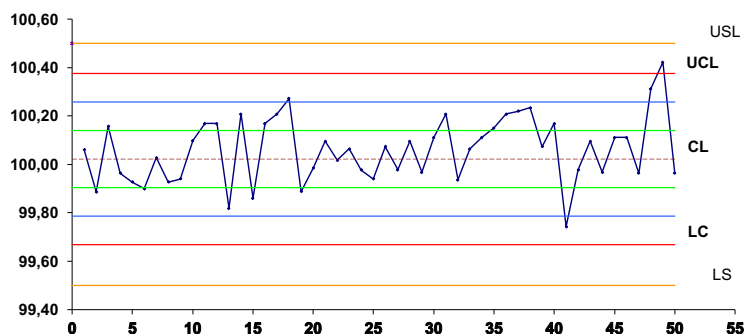

**WWW.ICONIC-SPACE.COM**





## Rejstřík | Index | Spis kodu produktů

1001-02-030	2	1033-22-150	7	1046-03-103	11	1120-07-020	16	1155-05-010	20	3025	26
1001-02-050	2	1033-22-200	7	1046-03-112	11	1121	15	1155-051-001	20	3025-2	26
1001-02-100	2	1038-02-050	7	1046-03-122	11	1122	15	1155-052-001	20	3025-3	26
1001-02-150	2	1038-02-100	7	1046-13-038	11	1123	15	1155-052-010	20	3025-4	26
1001-02-200	2	1038-02-150	7	1046-13-047	11	1124	15	1155-25-001	21	3026	26
1001-02-300	2	1039-02-050	6	1046-13-083	11	1125	15	1155-25-010	21	3026-30	26
1001-02-400	2	1039-02-075	6	1046-13-087	11	1125-02-013	16	1155-35-001	20	3034	10
1001-07-030	2	1039-02-100	6	1046-13-103	11	1126	15	1155-35-010	20	3035	10
1001-07-050	2	1039-02-150	6	1046-13-112	11	1127	15	1155-7	21	3036	10
1001-07-100	2	1039-02-200	6	1046-13-122	11	1129-1	14	1156-02-010	21	3037	10
1001-07-150	2	1039-02-250	6	1047-13-003	11	1130	14	1156-02-102	21	3039-02-130	27
1001-07-200	2	1039-02-300	6	1047-13-005	11	1131	14	1156-02-110	21	3039-02-188	27
1001-07-300	2	1039-02-400	6	1047-13-010	11	1131-02-032	14	1156-02-222	21	3039-02-280	27
1001-07-400	2	1039-12-050	6	1047-13-015	11	1131-07-020	14	1160	18	3039-02-375	27
1007-02-030	2	1039-12-075	6	1047-13-020	11	1132	14	1160-02-117	18	3039-02-500	27
1007-02-050	2	1039-12-100	6	1047-14-001	11	1132-02-013	14	1162-05-050	53	3039-02-750	27
1007-02-100	2	1039-12-150	6	1047-14-002	11	1133	14	1162-05-080	53	3040-02-045	27
1007-02-150	2	1039-12-200	6	1047-14-003	11	1134-0,005/D	15	1162-05-100	53	3042-02-900	27
1007-02-200	2	1039-12-250	6	1047-14-004	11	1134-0,01/D	15	1162-08-050	53	3044-02-160	27
1007-02-300	2	1039-12-300	6	1047-14-005	11	1134-0,02/D	15	1162-08-080	53	3045-02-630	27
1007-07-030	2	1039-12-400	6	1047-14-006	11	1134-0,03/D	15	1162-08-100	53	3046-02-180	27
1007-07-050	2	1039-14-050	6	1047-14-007	11	1134-0,04/D	15	1163-1	53	3047-02-710	27
1007-07-100	2	1039-14-100	6	1047-14-008	11	1134-0,05/D	15	2001	22	3048-02-315	27
1007-07-150	2	1039-14-150	6	1047-14-009	11	1134-0,06/D	15	2002	22	3049-06-315	27
1007-07-200	2	1039-14-200	6	1047-14-010	11	1134-0,07/D	15	2002-1	22	3049-06-355	27
1007-07-300	2	1039-17-050	6	1050-13-032	11	1134-0,08/D	15	2003	22	3049-06-400	27
1012-02-030	3	1039-17-075	6	1050-13-047	11	1134-0,09/D	15	2006	22	3049-06-500	27
1012-02-050	3	1039-17-100	6	1050-13-087	11	1134-0,10/D	15	2007	22	3049-06-560	27
1012-02-100	3	1039-17-150	6	1050-13-103	11	1134-0,12/D	15	2008	22	3049-06-620	27
1012-02-150	3	1039-17-200	6	1054	79	1134-0,15/D	15	2009	22	3049-06-630	27
1012-02-200	3	1039-17-250	6	1055	79	1134-0,18/D	15	2010	22	3049-06-710	27
1012-02-250	3	1039-17-300	6	1056	79	1134-0,20/D	15	2012	22	3049-06-900	27
1012-02-300	3	1039-17-400	6	1061-02-075	7	1134-0,25/D	15	2013	22	3049-08-110	27
1012-02-400	3	1039-22-050	6	1061-02-100	7	1134-0,30/D	15	2014	22	3049-08-120	27
1012-02-500	3	1039-22-075	6	1061-02-125	7	1134-0,35/D	15	2016	22	3049-08-130	27
1012-04-030	3	1039-22-100	6	1061-02-150	7	1134-0,40/D	15	2017	22	3049-08-210	27
1012-04-050	3	1039-22-150	6	1061-02-200	7	1134-0,45/D	15	2018	22	3049-08-240	27
1012-04-100	3	1039-22-200	6	1061-02-300	7	1134-0,50/D	15	2019	22	3049-08-270	27
1012-07-024	3	1039-22-250	6	1061-02-400	7	1134-0,55/D	15	2029-02-030	42	3049-08-300	27
1012-07-030	3	1039-22-300	6	1061-07-075	7	1134-0,60/D	15	2034-02-150	22	3049-08-340	27
1012-07-040	3	1039-22-400	6	1061-07-100	7	1134-0,65/D	15	2034-02-200	22	3049-08-380	27
1012-07-050	3	1039-22-500	6	1061-07-1000	7	1134-0,70/D	15	2034-02-300	22	3049-08-430	27
1012-07-100	3	1041-02-030	8	1061-07-125	7	1134-0,75/D	15	2034-02-500	22	3049-08-490	27
1012-07-150	3	1041-02-040	8	1061-07-150	7	1134-0,80/D	15	2040-02-150	22	3049-08-550	27
1012-07-200	3	1041-02-063	8	1061-07-200	7	1134-0,85/D	15	2040-02-200	22	3049-08-620	27
1017	5	1041-02-100	8	1061-07-300	7	1134-0,90/D	15	2040-02-250	22	3049-08-800	27
1017-02-015	5	1041-02-120	8	1061-07-400	7	1134-0,95/D	15	2040-02-300	22	3052	27
1017-02-030	5	1041-02-160	8	1061-07-500	7	1134-1,00/D	15	2040-02-500	22	3053	27
1017-02-050	5	1041-02-210	8	1061-07-600	7	1138-02-015	15	2050-05-150	23	3054	27
1017-02-100	5	1041-02-216	8	1061-07-750	7	1140	14	2050-05-200	23	3055	27
1017-02-150	5	1041-12-040	8	1070-02-030	78	1141	14	2050-05-300	23	3056	27
1017-02-200	5	1041-12-063	8	1070-02-050	78	1142	14	2050-25-150	23	3057	27
1017-05-015	5	1041-12-100	8	1070-02-100	78	1146	14	2050-25-150	23	3058	27
1017-05-030	5	1041-12-120	8	1072	78	1147	14	2050-25-150	23	3059	27
1017-05-050	5	1041-12-160	8	1089-02-120	13	1148	14	2051-05-150	23	3059-1	27
1017-05-100	5	1041-80	9	1089-02-200	13	1148-02-014	14	2051-05-200	23	3060	27
1018	5	1041-82	9	1089-02-250	13	1148-02-016	14	2051-05-300	23	4001	35
1019	5	1041-84	9	1089-07-120	13	1148-02-020	14	2051-05-500	23	4001-03-025	35
1020	5	1041-86	9	1089-07-200	13	1148-02-022	14	2052-05-150	23	4001-03-040	35
1021	5	1041-88	9	1089-07-250	13	1148-02-030	14	2070-02-150	24	4001-03-063	35
1022	5	1041-90	9	1089-07-315	13	1150	17	2070-02-200	24	4001-03-075	35
1022-0	5	1042-02-030	8	1092-02-254	13	1150-04-250	18	2070-02-250	24	4001-03-100	35
1022-02-030	5	1042-02-040	8	1092-02-268	13	1150-05-250	18	2070-02-300	24	4001-03-150	35
1022-02-050	5	1042-02-060	8	1093	13	1150-07-150	18	2074	24	4001-03-200	35
1022-02-100	5	1042-02-080	8	1093-20	13	1150-1	17	2074-1	24	4001-03-250	35
1022-1	5	1042-02-100	8	1094-02-008	12	1150-5	17	2075	24	4001-03-300	35
1023	5	1042-02-120	8	1094-02-010	12	1150-6	17	2075-1	24	4002	35
1023-02-030	4	1042-12-030	8	1094-02-012	12	1150-61	17	2078	24	4003	35
1023-02-050	4	1042-12-040	8	1094-02-015	12	1150-7	17	2078-1	24	4004	35
1023-02-100	4	1042-12-060	8	1094-03-008	12	1151	17	2078-2	24	4005	35
1023-05-030	4	1042-12-080	8	1094-03-010	12	1151-1	17	2078-3	24	4006-02-120	36
1023-05-050	4	1042-12-100	8	1094-03-012	12	1151-61	17	3001	24	4006-02-160	36
1023-05-100	4	1042-50	10	1094-03-015	12	1152	18	3002	24	4006-02-200	36
1023-05-150	4	1043-01-110	10	1094-04-010	12	1153	18	3014-02-020	25	4006-02-300	36
1023-05-200	4	1043-01-140	10	1094-1	12	1154-02-190	18	3014-02-030	25	4007-02-120	36
1023-25-030	4	1043-01-200	10	1094-2	12	1154-02-210	18	3014-02-050	25	4007-02-160	36
1023-25-050	4	1043-02-100	10	1094-3	12	1155-00-100	21	3014-02-100	25	4007-02-200	36
1023-25-100	4	1043-02-140	10	1095-1	12	1155-02-001	19	3020-02-030	25	4007-02-300	36
1024	5	1043-02-180	10	1119-10	14	1155-02-005	19	3020-02-050	25	4010	33
1025	5	1043-03-070	10	1120-02-010	16	1155-02-010	19	3020-02-060	25	4011	33
1026	5	1043-03-130	10	1120-02-012	16	1155-02-025	19	3022-05-020	25	4012	33
1027-07-050	3	1043-03-200	10	1120-02-013	16	1155-02-030	19	3022-05-030	25	4013	33
1027-07-100	3	1046-03-038	11	1120-02-014	16	1155-02-110	19	3022-05-050	25	4014	33
1033-12-050	7	1046-03-047	11	1120-02-015	16	1155-02-410	19	3022-05-060	25	4015	33
1033-12-075	7	1046-03-083	11	1120-02-016	16	1155-02-710	19	3022-05-080	25	4016	33
1033-22-100	7	1046-03-087	11	1120-05-011	16	1155-05-001	20	3022-05-100	25	4020	33

## Rejstrík | Index | Spis kodu produktů

4020-30	35	4033-17-025	30	4052	32	5115-02-250	38	6040-05-9001	20	6044-15-200	50
4020-31	35	4033-17-030	30	4053	32	5115-02-300	38	6040-05-9001	57	6044-25-125	50
4020-32	35	4033-17-040	30	4054	32	5115-02-400	38	6040-05-901	20	6044-25-150	50
4020-33	35	4033-17-050	30	4055	32	6000	41	6040-05-901	47	6044-35-125	50
4020-34	35	4033-22-007	28	4056	32	6000-02-150	41	6040-05-901	57	6044-35-150	50
4020-35	35	4033-22-010	28	4057	32	6000-02-200	41	6040-05-902	20	6044-45-150	50
4020-36	35	4033-22-015	28	4057-1	32	6000-02-300	41	6040-05-902	47	6044-55-150	50
4020-37	35	4033-22-020	28	4057-2	32	6000-1	41	6040-05-903	57	6044-55-200	50
4020-38	35	4033-22-025	28	4057-3	32	6000-12-150	41	6040-1	53	6044-65-150	50
4020-39	35	4033-22-030	28	4058	33	6000-2	41	6040-14-150	48	6050	53
4021	33	4033-22-040	28	4059	33	6000-20	41	6040-14-200	48	6050-02-150	53
4022	33	4033-22-050	28	4060	33	6000-21	41	6040-14-300	48	7002	54
4023	33	4033-22-060	28	4061	33	6000-25	41	6040-15-150	49	7002-00-025	55
4024	33	4033-22-075	28	4061-1	33	6000-26	41	6040-15-200	49	7002-00-050	55
4025	33	4033-22-100	28	4062	36	6000-3	41	6040-15-300	49	7002-00-075	55
4025-1	33	4033-22-150	28	4062-1	36	6000-4	41	6040-2	48	7002-00-100	55
4026-02-006	31	4033-22-200	28	4062-2	36	6000-7	41	6040-25-150	47	7002-02-025	55
4026-02-007	31	4033-22-250	28	4062-3	36	6002	42	6040-25-200	47	7004	54
4026-02-010	31	4034	32	4062-4	36	6002-90-1	42	6040-25-300	47	7006	54
4026-02-015	31	4034-02-007	29	4062-5	36	6003	42	6040-25-500	47	7008	54
4026-02-020	31	4034-02-010	29	4063-10	36	6003-90-1	42	6040-27-150	46	7011	54
4026-02-025	31	4034-02-015	29	4063-11	36	6005-10	43	6040-27-200	46	7013	54
4026-02-030	31	4034-02-020	29	4063-12	36	6005-15	43	6040-27-300	46	7015	54
4026-02-040	31	4034-02-025	29	4063-13	36	6005-20	43	6040-27-900	46	7017	54
4026-02-050	31	4034-02-030	29	4063-14	36	6005-25	43	6040-35-150	52	7019	54
4026-12-006	31	4034-02-040	29	4064-08-010	34	6005-50	43	6040-35-200	52	7021	54
4026-12-007	31	4034-02-050	29	4064-08-011	34	6005-55	43	6040-35-300	52	7023	54
4026-12-010	31	4034-02-060	29	4065	78	6006-2	43	6040-35-400	52	7025	54
4026-12-015	31	4034-02-075	29	4066	78	6007-02-160	43	6040-35-500	52	7025-0	54
4026-12-020	31	4034-02-100	29	4067	78	6007-02-200	43	6040-35-600	52	7026	54
4026-12-025	31	4034-07-007	30	4080	36	6007-02-250	43	6040-45-150	52	7026-0	54
4026-12-030	31	4034-07-010	30	4085	36	6007-02-300	43	6040-45-200	52	7027	54
4026-12-040	31	4034-07-015	30	5017-02-050	37	6007-02-400	43	6040-45-300	52	7027-1	54
4026-12-050	31	4034-07-020	30	5017-02-065	37	6007-02-500	43	6040-45-400	52	7027-2	54
4026-12-060	31	4034-07-025	30	5017-02-600	37	6007-07-015	43	6040-45-500	52	7027-3	54
4026-12-154	31	4034-07-030	30	5017-05-150	37	6007-07-020	43	6040-45-600	52	7027-4	54
4026-12-250	31	4034-07-040	30	5017-97-150	37	6007-07-030	43	6040-55-150	51	7027-5	54
4026-28-006	31	4034-07-050	30	5018-0	37	6013-02-150	42	6040-55-151	51	7028-31	55
4028	35	4034-12-007	29	5018-1	37	6013-02-200	42	6040-55-200	51	7028-32	55
4028-1	35	4034-12-010	29	5018-2	37	6013-02-300	42	6040-55-300	51	7028-33	55
4029	35	4034-12-015	29	5018-3	37	6015-02-100	44	6040-65-150	51	7028-34	55
4029-1	35	4034-12-020	29	5018-4	37	6015-02-125	44	6040-65-200	51	7028-35	55
4030	35	4034-12-025	29	5018-5	37	6015-02-150	44	6040-65-300	51	7028-36	55
4030-1	35	4034-12-030	29	5018-6	37	6015-02-200	44	6040-75-200	49	7028-37	55
4031	34	4034-12-040	29	5022-01-025	40	6015-08-040	44	6040-75-210	49	7028-38	55
4031-03-020	34	4034-12-050	29	5022-02-030	40	6015-08-050	44	6040-85-150	52	7028-41	55
4031-03-025	34	4034-12-060	29	5022-03-020	40	6015-08-060	44	6040-85-200	52	7028-42	55
4031-03-030	34	4034-12-075	29	5022-03-035	40	6015-08-100	44	6040-85-300	52	7028-43	55
4031-04-025	34	4034-12-100	29	5022-03-060	40	6015-08-150	44	6041-15-025	51	7028-44	55
4031-04-030	34	4034-17-007	30	5022-03-075	40	6015-12-100	44	6041-15-050	51	7028-45	55
4031-04-040	34	4034-17-010	30	5022-04-035	40	6015-12-125	44	6041-2	48	7028-46	55
4032	34	4034-17-015	30	5022-04-080	40	6015-12-150	44	6041-25-150	48	7030-05-025	57
4033-02-007	28	4034-17-020	30	5022-1	40	6015-12-200	44	6041-35-060	51	7030-05-050	57
4033-02-010	28	4034-17-025	30	5035-3	37	6015-22-150	44	6041-35-100	51	7030-05-075	57
4033-02-015	28	4034-17-030	30	5035-4	37	6015-22-200	44	6041-45-200	52	7030-05-100	57
4033-02-020	28	4034-17-040	30	5036	37	6015-32-125	44	6041-55-150	52	7030-97-030	56
4033-02-025	28	4034-17-050	30	5036-02-008	37	6015-32-150	44	6041-75-200	52	7030-97-066	56
4033-02-030	28	4034-22-007	29	5036-08-006	37	6015-32-200	44	6042-2	48	7030-97-102	56
4033-02-040	28	4034-22-010	29	5036-5	37	6015-42-150	44	6042-20	49	7031-02-025	57
4033-02-050	28	4034-22-015	29	5050-02-150	38	6015-42-200	44	6043-05-100	50	7031-02-050	57
4033-02-060	28	4034-22-020	29	5050-02-200	38	6015-52-200	44	6043-05-125	50	7031-02-075	57
4033-02-075	28	4034-22-025	29	5050-02-250	38	6015-52-300	44	6043-05-150	50	7031-02-100	57
4033-02-100	28	4034-22-030	29	5050-02-300	38	6015-62-100	44	6043-05-200	50	7031-02-125	57
4033-07-007	30	4034-22-040	29	5050-02-400	38	6015-72-200	44	6043-15-100	50	7031-02-150	57
4033-07-010	30	4034-22-050	29	5050-02-500	38	6015-72-300	44	6043-15-125	50	7031-02-175	57
4033-07-015	30	4034-22-060	29	5051-02-150	38	6022-02-150	45	6043-15-150	50	7031-02-200	57
4033-07-020	30	4034-22-075	29	5051-02-200	38	6022-12-150	45	6043-15-200	50	7040-05-010	58
4033-07-025	30	4034-22-100	29	5051-02-250	38	6022-22-150	45	6043-15-300	50	7040-1	58
4033-07-030	30	4034-22-150	29	5051-02-300	38	6022-32-150	45	6043-25-125	50	7040-15-010	58
4033-07-040	30	4034-22-200	29	5080-02-100	39	6022-42-200	45	6043-25-150	50	7041	58
4033-07-050	30	4034-22-250	29	5080-02-150	39	6022-52-150	45	6043-35-125	50	7041-02-025	58
4033-12-007	28	4035	32	5080-02-200	39	6022-52-200	45	6043-35-150	50	7041-02-050	58
4033-12-010	28	4036	32	5080-02-250	39	6022-62-100	45	6043-45-150	50	7043	59
4033-12-015	28	4037	32	5080-02-300	39	6029-02-100	42	6043-45-200	50	7051	59
4033-12-020	28	4038	32	5090-02-150	39	6040-00-075	49	6043-45-300	50	7052	59
4033-12-025	28	4039	32	5090-02-200	39	6040-01	53	6043-55-150	50	7053	59
4033-12-030	28	4040	32	5090-02-250	39	6040-02-150	48	6043-65-100	50	7054	59
4033-12-040	28	4041	32	5090-02-300	39	6040-02-200	48	6043-75-200	50	7055	59
4033-12-050	28	4042	32	5091-02-150	39	6040-02-300	48	6043-75-300	50	7056	59
4033-12-060	28	4043	32	5091-02-200	39	6040-05	53	6044-05-100	50	7057	59
4033-12-075	28	4045	32	5091-02-250	39	6040-05-100	47	6044-05-125	50	7058	59
4033-12-100	28	4046	32	5091-02-300	39	6040-05-150	47	6044-05-150	50	7070-02-025	59
4033-17-007	30	4047	32	5110-02-100	38	6040-05-151*	47	6044-05-200	50	7070-02-050	59
4033-17-010	30	4048	32	5110-02-150	38	6040-05-200	47	6044-15-100	50	7070-02-075	59
4033-17-015	30	4049	32	5115-02-150	38	6040-05-300	47	6044-15-125	50	7070-02-100	59
4033-17-020	30	4051	32	5115-02-200	38	6040-05-900	47	6044-15-150	50	7070-02-125	59



## Rejstřík | Index | Spis kodu produktů

7070-02-150	59	7097	61	8040-2	67	91028	73	92050H7	74	94010-6gD	76
7070-02-175	59	7098	61	8040-3	67	91029	73	92052H7	74	94010-6gZ	77
7070-02-200	59	7098-1	61	8040-4	67	91030	73	92055H7	74	94012-6gD	76
7075-02-025	60	7098-2	61	8041	69	91032	73	92060H7	74	94012-6gZ	77
7075-02-050	60	7098-3	61	8041-2	67	91033	73	92065H7	74	94014-6gD	76
7075-02-075	60	7098-4	61	8042	69	91034	73	92070H7	74	94014-6gZ	77
7075-02-100	60	7098-5	61	8042-1	69	91035	73	92075H7	74	94016-6gD	76
7075-02-125	60	7098-6	61	8042-2	67	91036	73	92080H7 *	74	94016-6gZ	77
7075-02-150	60	7098-7	61	8043	69	91038	73	92085H7 *	74	94018-6gD	76
7075-02-175	60	7098-8	61	8043-2	67	91040	73	92090H7 *	74	94018-6gZ	77
7075-05-025	60	7100-02-030	61	8044-10	68	91042	73	92095H7 *	74	94020-6gD	76
7075-05-050	60	7100-02-050	61	8044-11	68	91044	73	92100H7 *	74	94020-6gZ	77
7075-05-075	60	7100-02-075	61	8044-12	68	91045	73	93000-6H-012	72	94022-6gD	76
7075-05-100	60	7100-02-100	61	8044-13	68	91046	73	93002-5-6H	75	94022-6gZ	77
7075-05-125	60	7103	65	8044-14	68	91050	73	93002-6H	75	94024-6gD	76
7075-05-150	60	7103-02-025	65	8044-15	69	91055	73	93003-5-6H	75	94024-6gZ	77
7075-05-175	60	7110-0	64	8044-16	69	91060	73	93003-6H	75	94027-6gD	76
7076-02-025	60	7110-1	64	8044-17	69	91065	73	93004-6H	75	94027-6gZ	77
7076-05-025	60	7110-2	64	8044-20	68	91070	73	93004,5-6H	75	94030-6gD	76
7077-05-025	60	7110-3	64	8044-21	68	91075	73	93005-6H	75	94030-6gZ	77
7089-02-002	62	7110-5	64	8044-22	68	91080	73	93006-6H	75	94033-6gD	76
7089-02-003	62	7110-6	64	8045	71	91085	73	93007-6H	75	94033-6gZ	77
7089-02-004	62	7110-7	64	8046	71	91090	73	93008-6H	75	94036-6gD	76
7089-02-005	62	7110-80	64	8047	71	91095	73	93009-6H	75	94036-6gZ	77
7089-02-006	62	7110-81	64	8048	71	91100	73	93010-6H	75	94036-6gD	76
7089-02-008	62	7110-82	64	8050	71	91112,5	73	93012-6H	75	94039-6gD	76
7089-02-010	62	7110-83	64	8051	71	91125	73	93014-6H	75	94039-6gZ	77
7089-02-012	62	7110-85	64	8052	71	91137,5	73	93016-6H	75	94042-6gD	76
7089-02-016	62	7110-86	64	8053	71	91150	73	93018-6H	75	94042-6gZ	77
7089-02-020	62	7110-87	64	8054	70	91162,5	73	93020-6H	75	94045-6gD	76
7089-02-025	62	7110-90	64	8054-0	70	91175	73	93022-6H	75	94045-6gZ	77
7089-02-030	62	7110-91	64	8054-1	70	91187,5	73	93024-6H	75	94048-6gD	76
7089-02-040	62	7110-92	64	8055	71	91200	73	93027-6H	75	94048-6gZ	77
7089-02-050	62	7110-93	64	8055-1	71	91225	73	93030-6H	75	94301D	76
7089-02-063	62	7110-94	64	8055-2	71	91250	73	93033-6H	75	94301Z	77
7089-02-075	62	7110-95	64	8057-02-300	71	91275	73	93036-6H	75	94302D	76
7089-02-088	62	7120	66	8057-15-320	71	91300	73	93039-6H	75	94302Z	77
7089-02-100	62	7120-02-025	66	8060	79	92000H7-012	72	93042-6H	75	94303D	76
7089-02-125	62	7125	64	8065	79	92002,5H7	74	93045-6H	75	94303Z	77
7089-02-150	62	7125-1	64	8067	79	92002H7	74	93048-6H	75	94304D	76
7089-02-175	62	7125-12	64	8070	79	92003H7	74	93301	75	94304Z	77
7089-02-200	62	7125-2	64	8071	79	92004H7	74	93302	75	94305D	76
7089-02-225	62	7125-3	64	8074	79	92005H7	74	93303	75	94305Z	77
7089-02-250	62	7126	65	9001	78	92006H7	74	93304	75	94306D	76
7089-02-275	62	7126-02-025	65	9002	78	92007H7	74	93305	75	94306Z	77
7089-02-300	62	7126-02-050	65	9003	78	92008H7	74	93306	75	94307D	76
7089-03-003	62	7126-02-075	65	9030	26	92009H7	74	93307	75	94307Z	77
7089-03-006	62	7126-02-100	65	9031	26	92010H7	74	93308	75	94308D	76
7089-03-012	62	7126-1	65	9033	26	92011H7	74	93309	75	94308Z	77
7089-03-020	62	7126-2	65	9035	26	92012H7	74	93310	75	94309D	76
7089-03-040	62	7126-3	65	9038	26	92013H7	74	93311	75	94309Z	77
7089-03-100	62	7171-01-006	72	9040-02-050	79	92014H7	74	93312	75	94310D	76
7090-02-002	63	8001	66	9040-02-060	79	92015H7	74	93313	75	94310Z	77
7090-02-003	63	8001-2	69	9040-02-070	79	92016H7	74	93314	75	94311D	76
7090-02-004	63	8001-3	67	9040-02-080	79	92017H7	74	93315	75	94311Z	77
7090-02-005	63	8002	66	9040-02-100	79	92018H7	74	93316	75	94312D	76
7090-02-006	63	8002-02-003	66	9040-700	79	92019H7	74	93317	75	94312Z	77
7090-02-008	63	8002-02-005	66	9040-900	80	92020H7	74	93318	75	94313D	76
7090-02-010	63	8002-02-008	66	9040-935	80	92021H7	74	93319	75	94313Z	77
7090-02-012	63	8002-02-010	66	91002	73	92022H7	74	93320	75	94314D	76
7090-02-016	63	8002-10	71	91002,5	73	92023H7	74	93321	75	94314Z	77
7090-02-020	63	8002-2	69	91003	73	92024H7	74	93322	75	94315D	76
7090-02-025	63	8002-3	67	91003,5	73	92025H7	74	93323	75	94315Z	77
7090-02-030	63	8003	66	91004	73	92026H7	74	93324	75	94316D	76
7090-02-040	63	8003-2	69	91004,5	73	92027H7	74	94000-6g-12D	72	94316Z	77
7090-02-050	63	8003-3	67	91005	73	92028H7	74	94000-6g-12Z	72	94317D	76
7090-02-063	63	8004-2	69	91006	73	92029H7	74	94002-5-6gZ	77	94317Z	77
7090-02-075	63	8004-2-1	69	91007	73	92030H7	74	94002-6gD	76	94318D	76
7090-02-088	63	8004-3	67	91008	73	92031H7	74	94002-6gZ	77	94318Z	77
7090-02-100	63	8005	68	91009	73	92032H7	74	94002,5-6gD	76	S444-43-250	72
7090-02-125	63	8010	70	91010	73	92033H7	74	94003-5-6gZ	77	S678-32-0001	72
7090-02-150	63	8011	70	91011	73	92034H7	74	94003-6gD	76		
7090-02-175	63	8012	70	91012	73	92035H7	74	94003-6gZ	77		
7090-02-200	63	8013	70	91013	73	92036H7	74	94003,5-6gD	76		
7090-02-225	63	8014	70	91014	73	92037H7	74	94004-6gD	76		
7090-02-250	63	8017	70	91015	73	92038H7	74	94004-6gZ	77		
7090-02-275	63	8017-02-030	70	91016	73	92039H7	74	94005-6gD	76		
7090-02-300	63	8017-02-050	70	91017	73	92040H7	74	94005-6gZ	77		
7090-03-003	63	8018	70	91018	73	92041H7	74	94006-6gD	76		
7090-03-006	63	8019	70	91019	73	92042H7	74	94006-6gZ	77		
7090-03-012	63	8020	70	91020	73	92043H7	74	94007-6gD	76		
7090-03-020	63	8021	70	91022	73	92044H7	74	94007-6gZ	77		
7090-03-050	63	8039-3	67	91024	73	92045H7	74	94008-6gD	76		
7090-03-100	63	8039-5	67	91025	73	92046H7	74	94008-6gZ	77		
7095	61	8040	69	91026	73	92047H7	74	94009-6gD	76		
7096	61	8040-1	67	91027	73	92048H7	74	94009-6gZ	77		



[www.kinexmeasuring.com](http://www.kinexmeasuring.com)

